

# Trim Square Wallwash

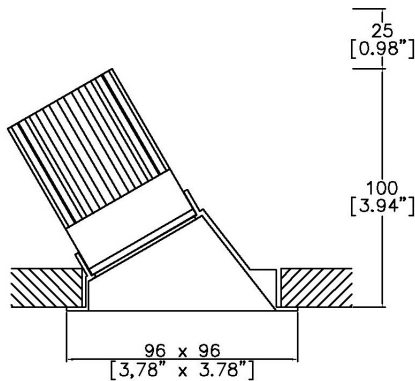

Trim (Round and Square) provides high performance electronics and architectural aesthetics in 3.8" and 3.8" x 3.8" trim. Trim products include adjustable, fixed and wallwash with flange. Tray, retrofit and housing installation methods (NIC, IC, AT, T24 and CCEA) Lucent modules available in a wide range of color temperatures, beam angles, intensities, and effects (Ambiance WarmDim and Dynamic Tuneable White). MR16 and GU10 LED lamp options available. TRIAC/Phase, 0-10v/1-10v, DMX and DALI/Digital dimming.



A960-LED-WW-SQ  
Cut-out 3.29"x3.29"  
(83.5x83.5mm)

LED Source	LED5IWD
CCT	3000K
Drive Current	500mA
Power inc Driver	17.1W
Beam Angle	39°
Delivered Lumens	620
Delivered Intensity cd	478
Efficacy lm/w	36
Forward Volt	29.1V
CRI	≥95 CRI
Test results at full output	

Project Ref: \_\_\_\_\_

Location Ref: \_\_\_\_\_

Specify fixture part number (All boxes must be filled in to correctly order)

A960-LED-WW-SQ [ ] [ ] [ ] LED5IWD [ ] 39 [ ] [ ] [ ] [ ] [ ] [ ] [ ] [ ]

**Finish**  
**WH** White  
**BK** Black

**Location**  
**XX** Damp as standard  
**WT** Wet

**Ceiling Thickness**  
**SC** Standard Ceiling (1/2"-5/8"-3/4")  
**C** Custom

**LED Type**  
**LED5IWD** LED5IWD (95CRI)

**CCT**  
**2720** 2700K - 2000K  
**3020** 3000K - 2000K

**Beam Angles**  
**39** 39

**Housing/Tray**  
**LMT-13-NIC** Mounting Tray Non-Insulated ceilings  
**LH-6.75-NIC** Housing 6.75" Non-Insulated ceilings  
**LH-8.50-AT/IC** Housing 8.50" Insulated/Air-tight ceilings and Chicago Plenum

**Mounting Hardware**  
**09** 9" to 15.25" - Adjustable Bar Hanger Lengths  
**14** 14" to 24" - Adjustable Bar Hanger Lengths  
**36** 28" to 36" - Adjustable Bar Hanger Lengths  
**BB** Butterfly Bracket  
**CB** Caterpillar Bracket

**Supply Voltage**  
**120** 120V  
**277** 277V

**Dimming Protocol**  
**S** Non-Dimmable  
**P** TRIAC/Phase (120V ONLY) (25-10% Minimum Dimming)\*\*\*  
**LP** Lutron Forward Phase 2-Wire (1% Dimming) (120V ONLY)  
**ESS** EcoSystem 5-Series (5% Dimming)  
**LHE** EcoSystem Hi-Lume Fade to Black (1% Dimming)  
**LAE** Lutron 3-Wire Hi-Lume (1% Dimming)  
**LHP** Lutron Hi-Lume Premier EcoSystem (0.1% Dimming)  
**A** 0-10V (15-5% Minimum Dimming)\*\*\*  
**ESD** EldoLED Solo DALI2 (0.1% Dimming)  
**EED** EldoLED Eco DALI2 (1% Dimming)  
**ESA** EldoLED Solo 0-10V/1-10V (0.1% Dimming)  
**EEA** EldoLED Eco 0-10V/1-10V (1% Dimming)  
**B** Bluetooth\*\*

**Emergency**  
**E** 3hr Emergency  
**ES** 3hr Self Test

**Louvre/Lens**  
**XX** Not required  
**LL45** Honeycomb  
**LLCC** Warm Tone  
**LLUV** UV

\*Refer to Technical Details for more information

## Housing dimensions



LH-6.75  
Non-insulated ceilings



LH-8.50  
Insulated/air-tight ceilings and  
Chicago Plenum

## Tray dimensions



LMT-13  
Non-insulated ceilings

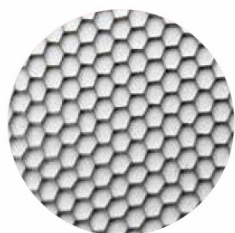

**Honeycomb Louvre (LL45)**



**Warm Tone (LLCC)**

---

## Technical Details

\*Custom color requires a paint chip or RAL code and may increase price and lead-time

It is the responsibility of the specifier/integrator/installer to check and ensure compatibility of any control equipment used. Additional cabling may be required depending on the dimming protocol specified.

\*\*Bluetooth (wireless) is a communication protocol. The exact dimming protocol must be confirmed to allow the selection of suitable drivers or Bluetooth devices.

\*\*\*Non specific driver type, dimming performance depending on exact driver used. Contact Lucent Lighting for more information.

^ Depth indicated is the minimum recess depth for the luminaire with a remote mounted LED driver. Installing a driver through either the luminaire cut-out or installation kit may require additional recess depth, please refer to the relevant installation instructions prior to purchase.

First Fix Requirement. Luminaire comprised of fixture body with ceiling trim and installation kit, which is to be fitted into the ceiling once finished. Ensure correct alignment of the installation kit before final assembly (see luminaire installation instructions for details)

Location. Tested from underside of the ceiling.

Data correct at time of publishing. It is the policy of Lucent Lighting to continually review and improve its products and therefore reserve the right to change any details of product or withdraw specifications without prior notice.

This specification sheet supersedes all previous versions.

All intellectual property rights pertaining to the product described above and to this document are owned by or licensed to Lucent Lighting, Incorporated. Lucent Lighting reserves the right to take whatever action is necessary to protect its intellectual property, patents and trademarks

Please notify Lucent Lighting Inc. inaccuracies. E&OE

---



## Light efficiency:

**36 Lumen/Watt**

## Light quality:

**CRI: 95.7**

## Color temperature:

**3000 K**

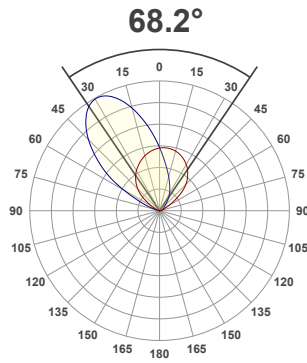

## Product name:

**A960-LED-WW-SQ -  
LED51WD-3020-39-500mA**

## Item number:

**Trim Square Wallwash -  
LED51WD-3020-39-500mA**

**Delivered information for above  
fixture and LED combination.**

**Output: 620 Lumen Peak intensity: 478 cd Power consumption: 17.1**

### CRI R values

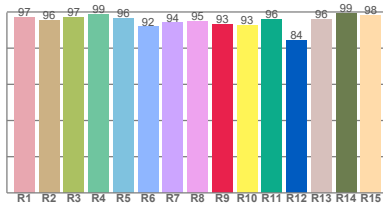

### TM30 C Values

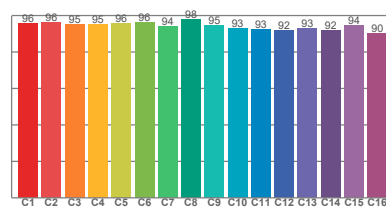

### Color vector graphics

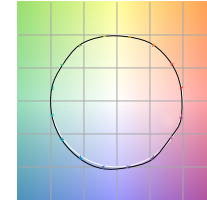

Color temperature	Color rendering index	Red component	Color fidelity	Color gamut	Color quality scale	Color coordinate cie 1931	Color coordinate cie 1931	Color coordinate	Color coordinate	Color deviation from black body
CCT	CRI	CRI R9	TM30 Rf	TM30 Rg	CQS	x	y	u	v	Δuv
3000 K	95.7	93.3	94.4	101.8	94.3	0.437	0.404	0.255	0.343	-0.0064

### Beam details

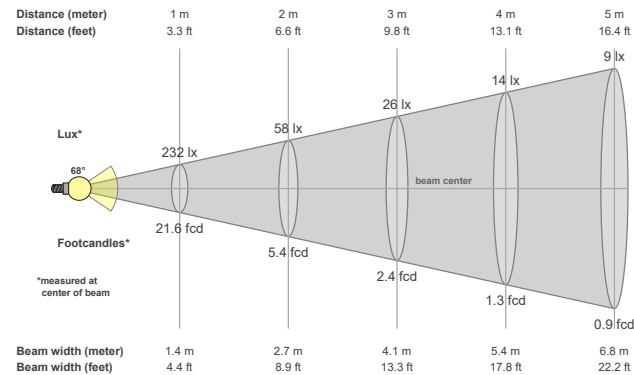

### Beam angles

Beam angle 50%	Field angle 10%	Cutoff angle 2,5%
68.2°	118.2°	149.3°

### Beam intensities

Peak intensity	Int. ratio in 120° cone	Int. ratio in 90° cone
478 cd	90.9%	65.4%

### Beam intensities from 1-20m

1m	2m	3m	4m	5m	6m	7m	8m	9m	10m	11m	12m	13m	14m	15m	16m	17m	18m	19m	20m
3.3ft	6.6ft	9.8ft	13.1ft	16.4ft	19.7ft	23ft	26.2ft	29.5ft	32.8ft	36.1ft	39.4ft	42.7ft	45.9ft	49.2ft	52.5ft	55.8ft	59.1ft	62.3ft	65.6ft
232lx	58lx	26lx	14lx	9lx	6lx	5lx	4lx	3lx	2lx	2lx	2lx	1lx	1lx	1lx	1lx	1lx	1lx	1lx	1lx
21.6fcd	5.4fcd	2.4fcd	1.3fcd	0.9fcd	0.6fcd	0.4fcd	0.3fcd	0.3fcd	0.2fcd	0.2fcd	0.1fcd	0.1fcd	0.1fcd	0.1fcd	0.1fcd	0.1fcd	0.1fcd	0.1fcd	0.1fcd

The above information is for 3000K colour temperature, for specific module information please see LED spec located on our website

For information regarding other colour temperatures please use the following factors for lumen output and candelas:

2700K = 0.93