

Line 2LED Cube

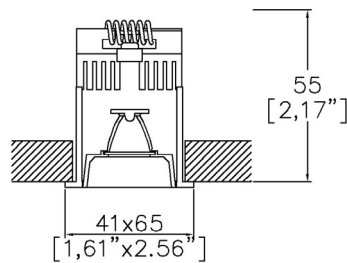

Line is a range of miniature ultra low glare recessed downlights with 1, 2, 5 or 10 cells. In fixed in a flanged or trimless installation kit. Available in 3 color temperatures and 3 beam angles. TRIAC/Phase, 0-10V/1-10V, DMX and DALI/digital dimming.



A2602-CB-TR
Cut out 59 x 35mm
(2.32" x 1.38")

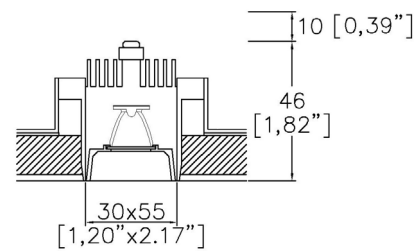

A2602-CB-TL
Cut out 59 x 35mm
(2.32" x 1.38")

LED Source	LED	LED	LED
CCT	3000K	3000K	3000K
Drive Current	500mA	500mA	500mA
Power inc Driver	3.6W	3.6W	3.6W
Beam Angle	12°	34°	48°
Delivered Lumens	235	250	246
Delivered Intensity cd	2107	657	392
Efficacy lm/w	65	69	68
Forward Volt	6V	6V	6V
CRI	≥90 CRI	≥90 CRI	≥90 CRI

Project Ref: _____

Location Ref: _____

Specify fixture part number (All boxes must be filled in to correctly order)

A2602-CB			BK		
----------	--	--	----	--	--

- Installation _____
- TR Flange
- TL Trimless
- CCT _____
- 27 2700K
- 30 3000K
- 40 4000K
- Finish _____
- BK Black
- Beam Angles _____
- 12 12
- 34 34
- 48 48
- Dimming Protocol^ _____
- S Non-Dimmable
- P TRIAC/Phase (120V ONLY) (25-10% Minimum Dimming)***
- LP Lutron Forward Phase 2-Wire (1% Dimming) (120V ONLY)
- ESS EcoSystem 5-Series (5% Dimming)
- LHE EcoSystem Hi-Lume Fade to Black (1% Dimming)
- LAE Lutron 3-Wire Hi-Lume (1% Dimming)
- LHP Lutron Hi-Lume Premier EcoSystem (0.1% Dimming)
- A 0-10V (15-5% Minimum Dimming)***
- ESD EldoLED Solo DALI2 (0.1% Dimming)
- EED EldoLED Eco DALI2 (1% Dimming)
- ESA EldoLED Solo 0-10V/1-10V (0.1% Dimming)
- EEA EldoLED Eco 0-10V/1-10V (1% Dimming)
- B Bluetooth**

*Refer to Technical Details for more information

^Not all power supplies are available for single connection, some require series connection with multiple fittings. Consult Lucent Lighting Inc for more information.

Technical Details

*Custom color requires a paint chip or RAL code and may increase price and lead-time

It is the responsibility of the specifier/integrator/installer to check and ensure compatibility of any control equipment used. Additional cabling may be required depending on the dimming protocol specified.

**Bluetooth (wireless) is a communication protocol. The exact dimming protocol must be confirmed to allow the selection of suitable drivers or Bluetooth devices.

***Non specific driver type, dimming performance depending on exact driver used. Contact Lucent Lighting for more information.

^ Depth indicated is the minimum recess depth for the luminaire with a remote mounted LED driver. Installing a driver through either the luminaire cut-out or installation kit may require additional recess depth, please refer to the relevant installation instructions prior to purchase.

First Fix Requirement. Luminaire comprised of fixture body with ceiling trim and installation kit, which is to be fitted into the ceiling once finished. Ensure correct alignment of the installation kit before final assembly (see luminaire installation instructions for details)

Location. Tested from underside of the ceiling.

Data correct at time of publishing. It is the policy of Lucent Lighting to continually review and improve its products and therefore reserve the right to change any details of product or withdraw specifications without prior notice.

This specification sheet supersedes all previous versions.

All intellectual property rights pertaining to the product described above and to this document are owned by or licensed to Lucent Lighting, Incorporated. Lucent Lighting reserves the right to take whatever action is necessary to protect its intellectual property, patents and trademarks

Please notify Lucent Lighting Inc. inaccuracies. E&OE



Light efficiency:



Light quality:



Color temperature:

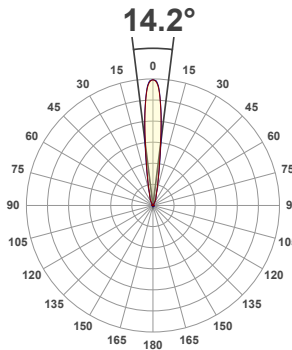

Product name:

**Line 2LED Cube 3000K 12°
500mA**

Item number:

2602-CB-30-12-500mA

**Delivered information for above
fixture and LED combination.**

Output: 235 Lumen Peak intensity: 2107 cd Power consumption: 3.6

CRI R values

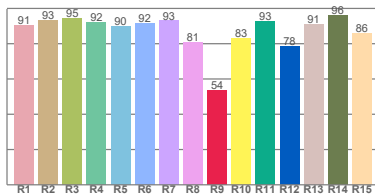

TM30 C Values

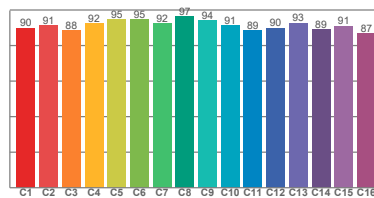

Color vector graphics

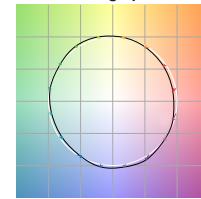

Color temperature	Color rendering index	Red component	Color fidelity	Color gamut	Color quality scale	Color coordinate cie 1931	Color coordinate cie 1931	Color coordinate	Color coordinate	Color deviation from black body
CCT	CRI	CRI R9	TM30 Rf	TM30 Rg	CQS	x	y	u	v	Δuv
3000 K	90.8	53.6	91.4	99.3	89.9	0.437	0.404	0.251	0.350	0.0024

Beam details

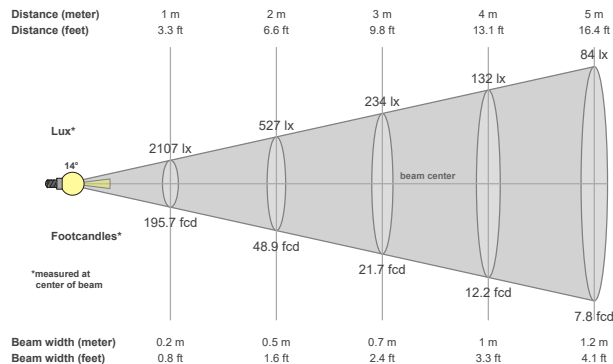

Beam angles

Beam angle 50%	Field angle 10%	Cutoff angle 2,5%
14.2°	32.6°	56.1°

Beam intensities

Peak intensity	Int. ratio in 120° cone	Int. ratio in 90° cone
2107 cd	99.6%	99.3%

Beam intensities from 1-20m

1m	2m	3m	4m	5m	6m	7m	8m	9m	10m	11m	12m	13m	14m	15m	16m	17m	18m	19m	20m
3.3ft	6.6ft	9.8ft	13.1ft	16.4ft	19.7ft	23ft	26.2ft	29.5ft	32.8ft	36.1ft	39.4ft	42.7ft	45.9ft	49.2ft	52.5ft	55.8ft	59.1ft	62.3ft	65.6ft
2107lx	527lx	234lx	132lx	84lx	59lx	43lx	33lx	26lx	21lx	17lx	15lx	12lx	11lx	9lx	8lx	7lx	7lx	6lx	5lx
195.7fcd	48.9fcd	21.7fcd	12.2fcd	7.8fcd	5.4fcd	4fcd	3.1fcd	2.4fcd	2fcd	1.6fcd	1.4fcd	1.2fcd	1fcd	0.9fcd	0.8fcd	0.7fcd	0.6fcd	0.5fcd	0.5fcd

The above information is for 3000K colour temperature, for specific module information please see LED spec located on our website

For information regarding other colour temperatures please use the following factors for lumen output and candelas:

2700K = 0.82

4000K = 1.11

Light efficiency:



Light quality:



Color temperature:

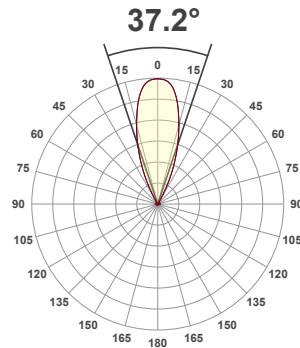

Product name:

**Line 2LED Cube 3000K 34°
500mA**

Item number:

2602-CB-30-34-500mA

**Delivered information for above
fixture and LED combination.**

Output: 250 Lumen Peak intensity: 657 cd Power consumption: 3.6

CRI R values

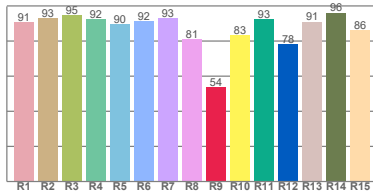

TM30 C Values

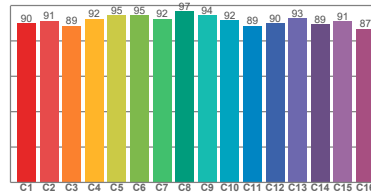

Color vector graphics

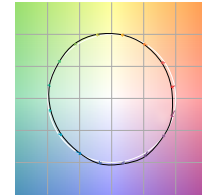

Color temperature	Color rendering index	Red component	Color fidelity	Color gamut	Color quality scale	Color coordinate cie 1931	Color coordinate cie 1931	Color coordinate	Color coordinate	Color deviation from black body
CCT	CRI	CRI R9	TM30 Rf	TM30 Rg	CQS	x	y	u	v	Δuv
3000 K	90.8	53.8	91.5	99.3	90.0	0.437	0.404	0.251	0.350	0.0025

Beam details

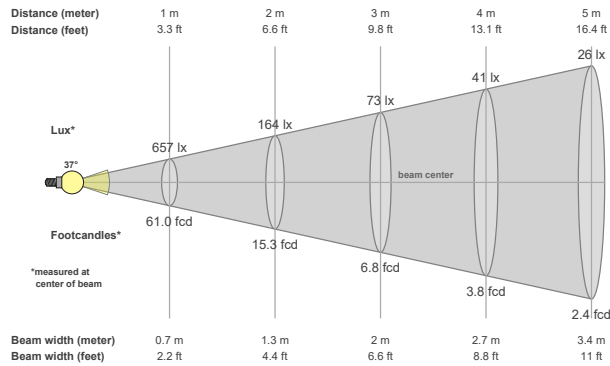

Beam angles

Beam angle 50%	Field angle 10%	Cutoff angle 2,5%
37.2°	56.7°	62.7°

Beam intensities

Peak intensity	Int. ratio in 120° cone	Int. ratio in 90° cone
657 cd	99.7%	99.4%

Beam intensities from 1-20m

1m	2m	3m	4m	5m	6m	7m	8m	9m	10m	11m	12m	13m	14m	15m	16m	17m	18m	19m	20m
3.3ft	6.6ft	9.8ft	13.1ft	16.4ft	19.7ft	23ft	26.2ft	29.5ft	32.8ft	36.1ft	39.4ft	42.7ft	45.9ft	49.2ft	52.5ft	55.8ft	59.1ft	62.3ft	65.6ft
657lx	164lx	73lx	41lx	26lx	18lx	13lx	10lx	8lx	7lx	5lx	5lx	4lx	3lx	3lx	3lx	2lx	2lx	2lx	2lx
61fcd	15.3fcd	6.8fcd	3.8fcd	2.4fcd	1.7fcd	1.2fcd	1fcd	0.8fcd	0.6fcd	0.5fcd	0.4fcd	0.4fcd	0.3fcd	0.3fcd	0.2fcd	0.2fcd	0.2fcd	0.2fcd	0.2fcd

The above information is for 3000K colour temperature, for specific module information please see LED spec located on our website

For information regarding other colour temperatures please use the following factors for lumen output and candelas:

2700K = 0.82

4000K = 1.11

Light efficiency:



Light quality:



Color temperature:

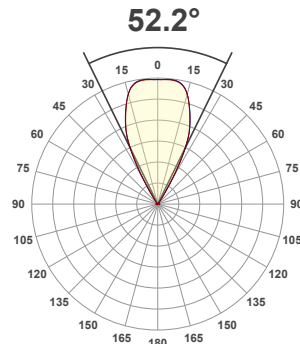

Product name:

**Line 2LED Cube 3000K 48°
500mA**

Item number:

2602-CB-30-48-500mA

Delivered information for above fixture and LED combination.

Output: 246 Lumen Peak intensity: 392 cd Power consumption: 3.6

CRI R values

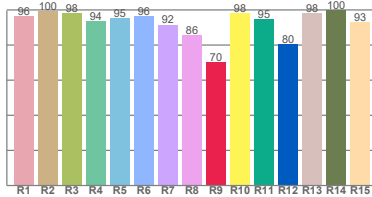

TM30 C Values

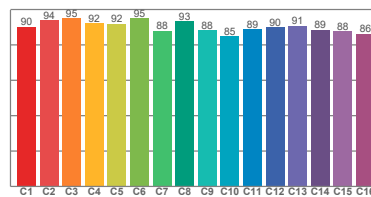

Color vector graphics

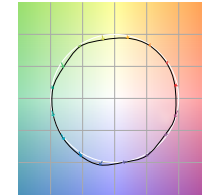

Color temperature	Color rendering index	Red component	Color fidelity	Color gamut	Color quality scale	Color coordinate cie 1931	Color coordinate cie 1931	Color coordinate	Color coordinate	Color deviation from black body
CCT	CRI	CRI R9	TM30 Rf	TM30 Rg	CQS	x	y	u	v	Δuv
3000 K	94.6	70.4	90.5	97.0	92.0	0.437	0.404	0.247	0.345	-0.0011

Beam details

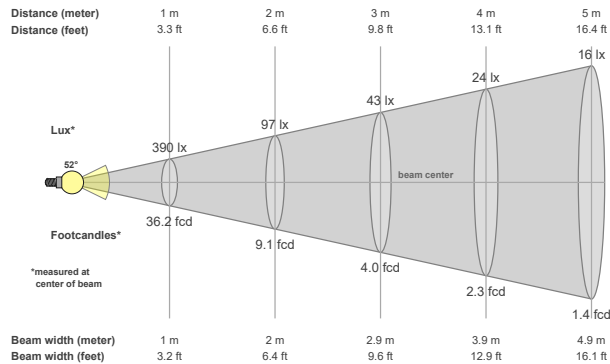

Beam angles

Beam angle 50%	Field angle 10%	Cutoff angle 2,5%
52.2°	65.2°	72.1°

Beam intensities

Peak intensity	Int. ratio in 120° cone	Int. ratio in 90° cone
392 cd	99.8%	99.6%

Beam intensities from 1-20m

1m	2m	3m	4m	5m	6m	7m	8m	9m	10m	11m	12m	13m	14m	15m	16m	17m	18m	19m	20m
3.3ft	6.6ft	9.8ft	13.1ft	16.4ft	19.7ft	23ft	26.2ft	29.5ft	32.8ft	36.1ft	39.4ft	42.7ft	45.9ft	49.2ft	52.5ft	55.8ft	59.1ft	62.3ft	65.6ft
390lx	97lx	43lx	24lx	16lx	11lx	8lx	6lx	5lx	4lx	3lx	3lx	2lx	2lx	2lx	2lx	1lx	1lx	1lx	1lx
36.2fcd	9.1fcd	4fcd	2.3fcd	1.4fcd	1fcd	0.7fcd	0.6fcd	0.4fcd	0.4fcd	0.3fcd	0.3fcd	0.2fcd	0.2fcd	0.2fcd	0.1fcd	0.1fcd	0.1fcd	0.1fcd	0.1fcd

The above information is for 3000K colour temperature, for specific module information please see LED spec located on our website

For information regarding other colour temperatures please use the following factors for lumen output and candelas:

2700K = 0.82

4000K = 1.11