

## ProSpex Gimbal Mini Twin

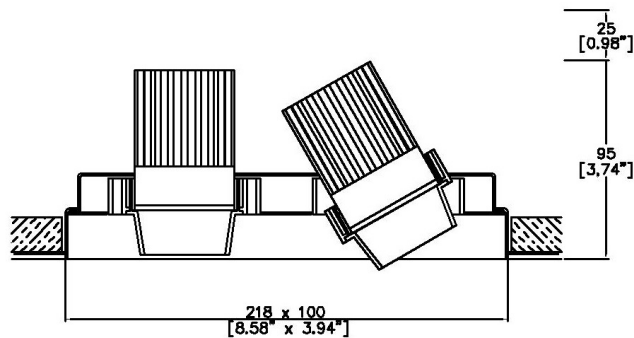

216 x 100mm (8.58" x 3.94") overall trimless dimension. Available with standard trim kit or plaster-in kit for flush appearance. Family of matching products also available. Required depth height + 25mm^



216/2-LED-TL  
Cut-out 224 x 108mm

LED Source	LED51TW	LED51TW
CCT range 5000K-2000K	@ 3000K	@ 3000K
Drive Current (max per channel)	700mA	700mA
Power inc Driver Max	15.1W	15.1W
Beam Angle	25°	35°
Delivered Lumens	535	611
Delivered Intensity cd	1952	1241
Efficacy lm/w	35	40
Forward Volt (max per channel)	18.4V	18.4V
CRI	≥95 CRI	≥95 CRI

Project Ref: \_\_\_\_\_

Location Ref: \_\_\_\_\_

Fixture Order Code:



Fixture

216/2-LED-TL

Gimbal Mini Twin Trimless with LED51

Gimbal Finish

WH  
BK  
RAL

White  
Black  
Custom RAL Colour\*

Coverplate Finish

WH  
BK  
RAL

White  
Black  
Custom RAL Colour\*

Trimless Kit Finish

WH  
BK  
RAL

White  
Black  
Custom RAL Colour\*

Emergency

E  
ED  
ES

Maintained 3hr Emergency  
Maintained 3hr DALI Self Test  
Maintained 3hr Self Test

LED Order Code:



LED

LED51TW LED50 ONE Tuneable White

CCT

5020

5000K - 2000K

Beam

25  
35

25°  
35°

Protocol

D6  
D8  
B

DALI Type 6\*\*  
DALI Type 8\*\*  
Bluetooth\*\*\*

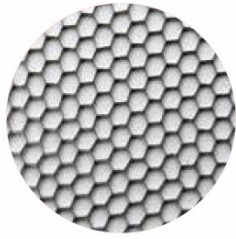

Honeycomb Louvre



Diffusing Lens



Frosted Lens

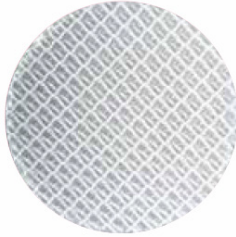

Heavy Spread Lens



Linear Spread Lens



Warm Tone

Accessories Order Code:

Louvre/Lens

- LL45 Honeycomb Louvre
- LLCC Warm Tone Lens
- LLUV UV Lens
- LLDF Diffusing Lens
- LLFR Frosted Lens
- LLLS Linear Spread Lens
- LLHS Heavy Spread Lens

Technical Details

\*Custom RAL code must be specified. Custom RAL colours can increase prices and lead times

Dimming. Whilst Lucent can offer the majority of its luminaires with various dimming options, it remains the responsibility of the specifier/installer to check and ensure compatibility of any control equipment used. Additional cabling may be required depending on the dimming protocol specified.

\*\*DALI Type 6 requires two DALI addresses, one for CCT control the other for Intensity control. DALI Type 8 is a single DALI Type 8 address for CCT and Intensity control. Please check which control system is being used before specifying.

\*\*\*Bluetooth (wireless) is the communication method. The exact dimming protocol must be confirmed to allow the selection of suitable drivers or bluetooth devices.

^ Depth indicated is the minimum recess depth for the luminaire with a remote mounted LED driver. Installing a driver through either the luminaire cut-out or installation kit may require additional recess depth, please refer to the relevant luminaire installation instructions for further details. Data correct at time of publishing

First Fix Requirement. Luminaire comprised of fixture body with ceiling trim and installation kit, which is to be fitted into the ceiling once finished. Ensure correct alignment of the installation kit before final assembly (see luminaire installation instructions for details)

IP Rating. Tested from underside of the ceiling

It is the policy of Lucent Lighting to continually review and improve its products and therefore reserve the right to change any details of product or withdraw specifications without prior notice.

Luminaires designed to comply with EN60598 and all other standards.

This specification sheet supersedes all previous versions.

All intellectual property rights pertaining to the product described above and to this document are owned by or licensed to Lucent Lighting Ltd.

We reserve the right to take whatever action is necessary to protect those intellectual property rights.

Please notify Lucent Lighting Ltd of any inaccuracies immediately. E&OE

**Light efficiency:**

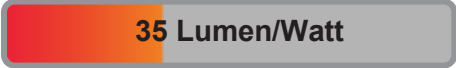

**Light quality:**



**Color temperature:**

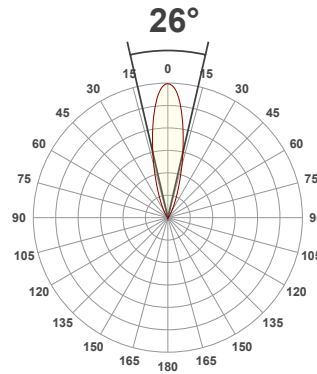

Product name:

**Gimbal Mini Element-LED - LED51TW-5020-25 @ 3000K**

Item number:

**Gimbal Mini Element - LED51TW-5020-25 @ 3000K**

**Delivered information for above fixture and LED combination.**

**Output: 535 Lumen    Peak intensity: 1952 cd    Power consumption: 15.1**

**CRI R values**

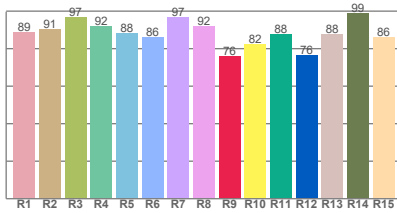

**TM30 C Values**

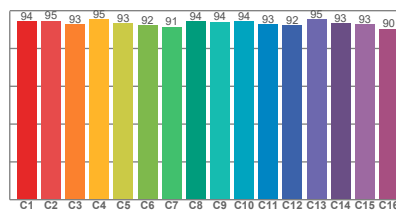

**Color vector graphics**

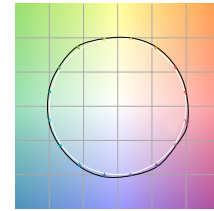

Color temperature	Color rendering index	Red component	Color fidelity	Color gamut	Color quality scale	Color coordinate cie 1931	Color coordinate cie 1931	Color coordinate	Color coordinate	Color deviation from black body
CCT	CRI	CRI R9	TM30 Rf	TM30 Rg	CQS	x	y	u	v	Δuv
3000 K	91.3	75.9	93.5	106.6	93.8	0.437	0.404	0.254	0.334	-0.0135

**Beam details**

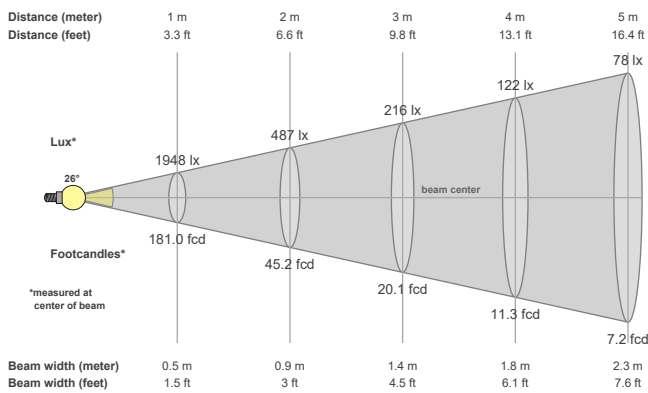

**Beam angels**

Beam angle 50%	Field angle 10%	Cutoff angle 2,5%
26°	52.2°	72.3°

**Beam intensities**

Peak intensity	Int. ratio in 120° cone	Int. ratio in 90° cone
1952 cd	99.5%	97.9%

**Beam intensities from 1-20m**

1m	2m	3m	4m	5m	6m	7m	8m	9m	10m	11m	12m	13m	14m	15m	16m	17m	18m	19m	20m
3.3ft	6.6ft	9.8ft	13.1ft	16.4ft	19.7ft	23ft	26.2ft	29.5ft	32.8ft	36.1ft	39.4ft	42.7ft	45.9ft	49.2ft	52.5ft	55.8ft	59.1ft	62.3ft	65.6ft
1948lx	487lx	216lx	122lx	78lx	54lx	40lx	30lx	24lx	19lx	16lx	14lx	12lx	10lx	9lx	8lx	7lx	6lx	5lx	5lx
181fcd	45.2fcd	20.1fcd	11.3fcd	7.2fcd	5fcd	3.7fcd	2.8fcd	2.2fcd	1.8fcd	1.5fcd	1.3fcd	1.1fcd	0.9fcd	0.8fcd	0.7fcd	0.6fcd	0.6fcd	0.5fcd	0.5fcd

All the above information for fixtures with LED51TW-5020 modules are tested at 3000K

Factors to adjust lumen output for the following CCTs at 100% output for the colour are as follows:

2000K = 0.67

2700K = 0.84

3500K = 1.085

4000K = 1.113

5000K = 1.087

**Light efficiency:**



**Light quality:**



**Color temperature:**

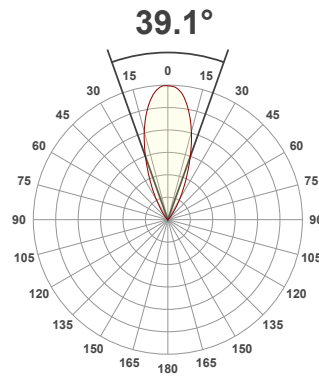

Product name:

**Gimbal Mini Element-LED - LED51TW-5020-35 @ 3000K**

Item number:

**Gimbal Mini Element - LED51TW-5020-35 @ 3000K**

**Delivered information for above fixture and LED combination.**

**Output: 611 Lumen Peak intensity: 1241 cd Power consumption: 15.1**

CRI R values

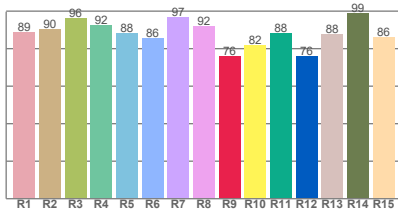

TM30 C Values

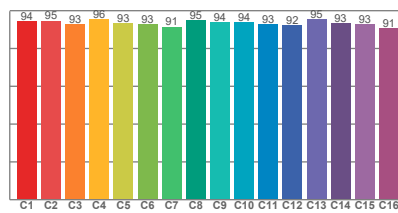

Color vector graphics

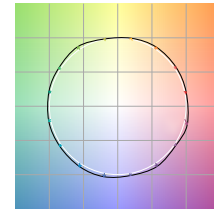

Color temperature	Color rendering index	Red component	Color fidelity	Color gamut	Color quality scale	Color coordinate cie 1931	Color coordinate cie 1931	Color coordinate	Color coordinate	Color deviation from black body
CCT	CRI	CRI R9	TM30 Rf	TM30 Rg	CQS	x	y	u	v	Δuv
3000 K	91.3	76.2	93.6	106.2	93.9	0.437	0.404	0.253	0.334	-0.0133

**Beam details**

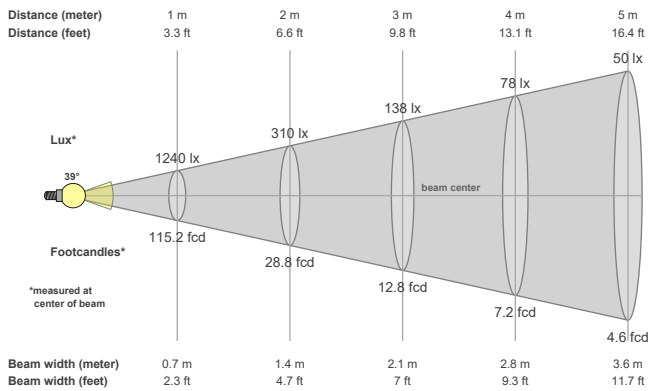

**Beam angels**

Beam angle 50%	Field angle 10%	Cutoff angle 2,5%
39.1°	67.8°	86.6°

**Beam intensities**

Peak intensity	Int. ratio in 120° cone	Int. ratio in 90° cone
1241 cd	99.7%	97.6%

**Beam intensities from 1-20m**

1m	2m	3m	4m	5m	6m	7m	8m	9m	10m	11m	12m	13m	14m	15m	16m	17m	18m	19m	20m
3.3ft	6.6ft	9.8ft	13.1ft	16.4ft	19.7ft	23ft	26.2ft	29.5ft	32.8ft	36.1ft	39.4ft	42.7ft	45.9ft	49.2ft	52.5ft	55.8ft	59.1ft	62.3ft	65.6ft
1240lx	310lx	138lx	78lx	50lx	34lx	25lx	19lx	15lx	12lx	10lx	9lx	7lx	6lx	6lx	5lx	4lx	4lx	3lx	3lx
115.2fcd	28.8fcd	12.8fcd	7.2fcd	4.6fcd	3.2fcd	2.4fcd	1.8fcd	1.4fcd	1.2fcd	1fcd	0.8fcd	0.7fcd	0.6fcd	0.5fcd	0.5fcd	0.4fcd	0.4fcd	0.3fcd	0.3fcd

All the above information for fixtures with LED51TW-5020 modules are tested at 3000K

Factors to adjust lumen output for the following CCTs at 100% output for the colour are as follows:

2000K = 0.67

2700K = 0.84

3500K = 1.085

4000K = 1.113

5000K = 1.087