

ProSpex Focus60 Accent

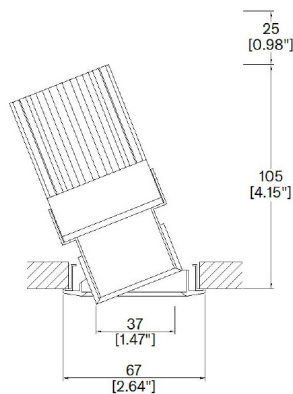

67mm (2.64") overall diameter. Up to 25° tilt. Available with standard trim kit. Family of matching products also available. Required depth height + 25mm[^]



063-LED
Cut-out 62mm Ø

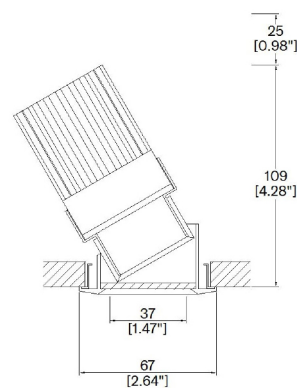

063-LED-54
Cut-out 62mm Ø

LED Source	LED51SS
CCT	3000K
Drive Current	500mA
Power inc Driver	6.75W
Beam Angle	7°
Delivered Lumens	447
Delivered Intensity cd	18648
Efficacy lm/w	67
Forward Volt	11.5V
CRI	≥90 CRI

Project Ref: _____

Location Ref: _____

Fixture Order Code: - - -

Fixture
063-LED Focus60 Accent with LED51

IP Rating
54 IP54

Finish
WH White
BK Black
RAL Custom RAL Colour*

Emergency
E Maintained 3hr Emergency
ED Maintained 3hr DALI Self Test
ES Maintained 3hr Self Test



LED Order Code: - - -

LED
LED51SS LED51 SuperSpot

CCT
927 90 CRI 2700K
930 90 CRI 3000K
940 90 CRI 4000K

Beam
7 7°

Protocol
S Non-Dim
A Analogue (0-10v)
P Phase
D DALI
B Bluetooth**



Honeycomb Louvre



Diffusing Lens



Frosted Lens



Heavy Spread Lens



Linear Spread Lens



Warm Tone

Accessories Order Code:

Louvre/Lens

- LL45 Honeycomb Louvre
- LLCC Warm Tone Lens
- LLUV UV Lens
- LLDF Diffusing Lens
- LLFR Frosted Lens
- LLLS Linear Spread Lens
- LLHS Heavy Spread Lens

Technical Details

*Custom RAL code must be specified. Custom RAL colours can increase prices and lead times

Dimming. Whilst Lucent can offer the majority of its luminaires with various dimming options, it remains the responsibility of the specifier/installer to check and ensure compatibility of any control equipment used. Additional cabling may be required depending on the dimming protocol specified.

**Bluetooth (wireless) is the communication method. The exact dimming protocol must be confirmed to allow the selection of suitable drivers or bluetooth devices.

^ Depth indicated is the minimum recess depth for the luminaire with a remote mounted LED driver. Installing a driver through either the luminaire cut-out or installation kit may require additional recess depth, please refer to the relevant luminaire installation instructions for further details. Data correct at time of publishing

First Fix Requirement. Luminaire comprised of fixture body with ceiling trim and installation kit, which is to be fitted into the ceiling once finished. Ensure correct alignment of the installation kit before final assembly (see luminaire installation instructions for details)

IP Rating. Tested from underside of the ceiling

It is the policy of Lucent Lighting to continually review and improve its products and therefore reserve the right to change any details of product or withdraw specifications without prior notice.

Luminaires designed to comply with EN60598 and all other standards.

This specification sheet superseded all previous versions.

All intellectual property rights pertaining to the product described above and to this document are owned by or licensed to Lucent Lighting Ltd.

We reserve the right to take whatever action is necessary to protect those intellectual property rights.

Please notify Lucent Lighting Ltd of any inaccuracies immediately. E&OE

Light efficiency:



Light quality:



Color temperature:

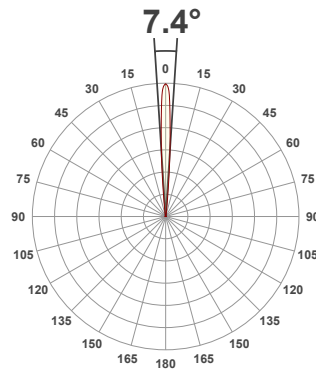

Product name:

Focus 60_90_Multi - LED51 SuperSpot, 3000K, 7°, 500mA

Item number:

Focus 60_90_Multi - LED51SS-30-7-500mA

Delivered information for above fixture and LED combination.

Output: 447 Lumen Peak intensity: 18648 cd Power consumption: 6.7

CRI R values

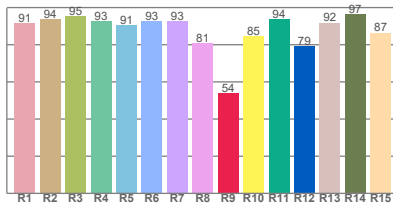

TM30 C Values

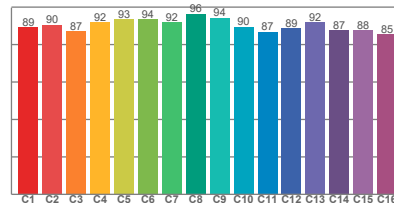

Color vector graphics

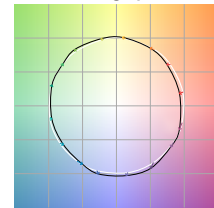

Color temperature	Color rendering index	Red component	Color fidelity	Color gamut	Color quality scale	Color coordinate cie 1931	Color coordinate cie 1931	Color coordinate	Color coordinate	Color deviation from black body
CCT	CRI	CRI R9	TM30 Rf	TM30 Rg	CQS	x	y	u	v	Δuv
3040 K	91.3	53.8	90.4	99.8	90.1	0.437	0.408	0.249	0.349	0.0016

Beam details

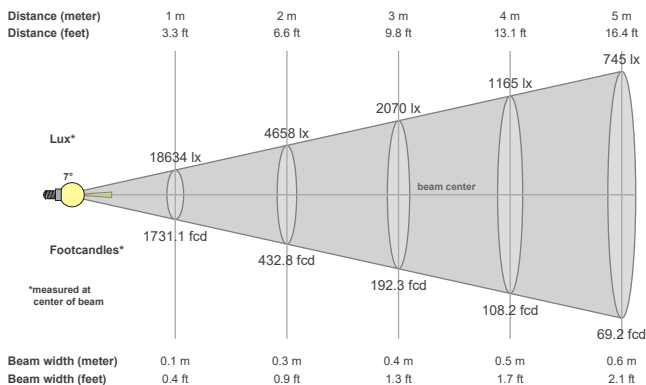

Beam angels

Beam angle 50%	Field angle 10%	Cutoff angle 2,5%
7.4°	12.9°	20.3°

Beam intensities

Peak intensity	Int. ratio in 120° cone	Int. ratio in 90° cone
18648 cd	99.4%	99.1%

Beam intensities from 1-20m

1m	2m	3m	4m	5m	6m	7m	8m	9m	10m	11m	12m	13m	14m	15m	16m	17m	18m	19m	20m
3.3ft	6.6ft	9.8ft	13.1ft	16.4ft	19.7ft	23ft	26.2ft	29.5ft	32.8ft	36.1ft	39.4ft	42.7ft	45.9ft	49.2ft	52.5ft	55.8ft	59.1ft	62.3ft	65.6ft
18634lx	4658lx	2070lx	1165lx	745lx	518lx	380lx	291lx	230lx	186lx	154lx	129lx	110lx	95lx	83lx	73lx	64lx	58lx	52lx	47lx
1731.1fcd	432.8fcd	192.3fcd	108.2fcd	69.2fcd	48.1fcd	35.3fcd	27fcd	21.4fcd	17.3fcd	14.3fcd	12fcd	10.2fcd	8.8fcd	7.7fcd	6.8fcd	6fcd	5.3fcd	4.8fcd	4.3fcd

The above information is for 3000K colour temperature, for specific module information please see LED spec located on our website

For information regarding other colour temperatures please use the following factors for lumen output and candelas:

2700K = 0.9
4000K = 1.08