

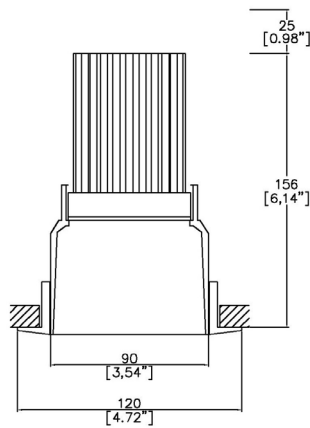

ProSpex Soft90 Fixed



120mm (4.72") overall trim diameter. 90mm (3.54") overall trimless diameter. Available with standard trim kit or plaster-in kit for flush appearance. Family of matching products also available. Required depth height + 25mm[^]



090-LED-TR
Cut-out 105mm Ø

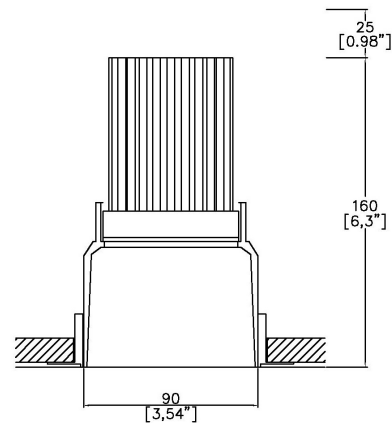

090-LED-TL
Cut-out 102mm Ø

LED Source	LED71WD	LED71WD	LED71WD
CCT	3000K	3000K	3000K
Drive Current	1000mA	1000mA	1000mA
Power inc Driver	27.0W	27.0W	27.0W
Beam Angle	19°	23°	42°
Delivered Lumens	1602	1503	1582
Delivered Intensisty cd	6480	5217	2243
Efficacy lm/w	58	55	58
Forward Volt	23V	23V	23V

Test results at full output

Project Ref: _____

Location Ref: _____

Fixture Order Code: - - - - -

Fixture	090-LED	Soft90 Fixed with LED71
Installation	TR TL	Trim Trimless
Body Finish	WH BK RAL	White Black Custom RAL Colour*
Trim Finish (Leave blank if trimless)	WH BK RAL	White Black Custom RAL Colour*
IP Rating	65	IP65
Emergency	E ED ES	Maintained 3hr Emergency Maintained 3hr DALI Self Test Maintained 3hr Self Test



LED Order Code: - - -

LED	LED71WD	LED70 ONE Ambiance WarmDim
CCT	2720 3020	2700K - 2000K 3000K - 2000K
Beam	19 23 42	19° 23° 42°
Protocol	S A P D B	Non-Dim Analogue (0-10v) Phase DALI Bluetooth**



Honeycomb Louvre



Diffusing Lens



Frosted Lens

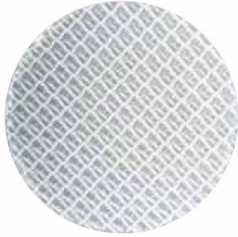

Heavy Spread Lens



Linear Spread Lens



Warm Tone

Accessories Order Code:

Louvre/Lens

- MD45 Honeycomb Louvre
- MDCC Warm Tone Lens
- MDUV UV Lens
- MDDF Diffusing Lens
- MDFR Frosted Lens
- MDLS Linear Spread Lens
- MDHS Heavy Spread Lens

Technical Details

*Custom RAL code must be specified. Custom RAL colours can increase prices and lead times

Dimming. Whilst Lucent can offer the majority of its luminaires with various dimming options, it remains the responsibility of the specifier/installer to check and ensure compatibility of any control equipment used. Additional cabling may be required depending on the dimming protocol specified.

**Bluetooth (wireless) is the communication method. The exact dimming protocol must be confirmed to allow the selection of suitable drivers or bluetooth devices.

^ Depth indicated is the minimum recess depth for the luminaire with a remote mounted LED driver. Installing a driver through either the luminaire cut-out or installation kit may require additional recess depth, please refer to the relevant luminaire installation instructions for further details.Data correct at time of publishing

First Fix Requirement. Luminaire comprised of fixture body with ceiling trim and installation kit, which is to be fitted into the ceiling once finished. Ensure correct alignment of the installation kit before final assembly (see luminaire installation instructions for details)

IP Rating. Tested from underside of the ceiling

It is the policy of Lucent Lighting to continually review and improve its products and therefore reserve the right to change any details of product or withdraw specifications without prior notice.

Luminaires designed to comply with EN60598 and all other standards.

This specification sheet superseded all previous versions.

All intellectual property rights pertaining to the product described above and to this document are owned by or licensed to Lucent Lighting Ltd.

We reserve the right to take whatever action is necessary to protect those intellectual property rights.

Please notify Lucent Lighting Ltd of any inaccuracies immediately. E&OE

Light efficiency:



Light quality:



Color temperature:

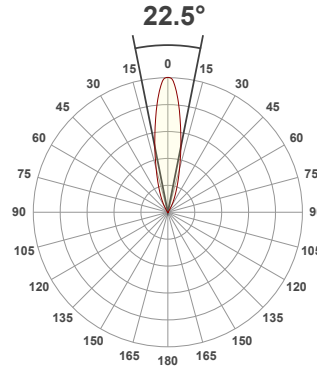
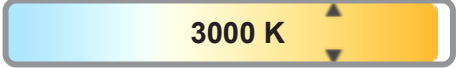

Product name:

090-LED-TL_TR - LED71WD-3020-19

Item number:

Soft90 fixed - LED71WD 3020-19 @ 1000mA

Delivered information for above fixture and LED combination.

Output: 1602 Lumen Peak intensity: 6480 cd Power consumption: 27.5

CRI R values

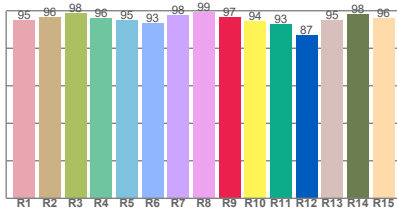

TM30 C Values

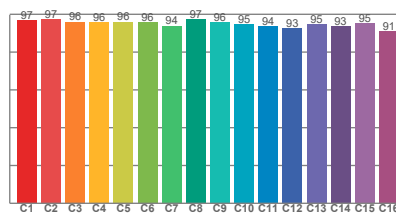

Color vector graphics

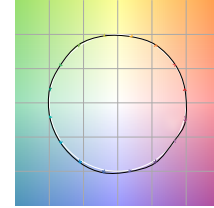

Color temperature	Color rendering index	Red component	Color fidelity	Color gamut	Color quality scale	Color coordinate cie 1931	Color coordinate cie 1931	Color coordinate	Color coordinate	Color deviation from black body
CCT	CRI	CRI R9	TM30 Rf	TM30 Rg	CQS	x	y	u	v	Δuv
3000 K	96.4	96.6	95.2	102.8	95.5	0.437	0.404	0.251	0.348	-0.0043

Beam details

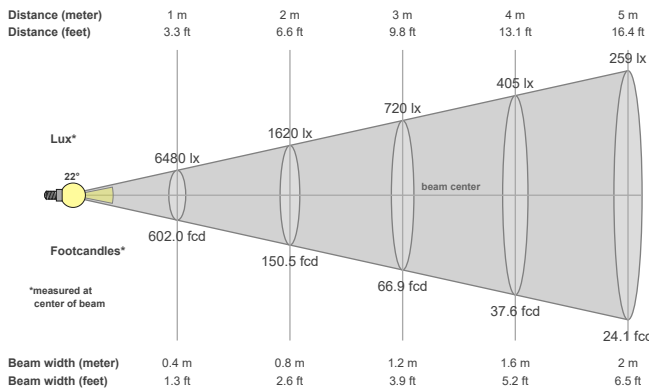

Beam angels

Beam angle 50%	Field angle 10%	Cutoff angle 2,5%
22.5°	51.4°	67.3°

Beam intensities

Peak intensity	Int. ratio in 120° cone	Int. ratio in 90° cone
6480 cd	97.7%	94.6%

Beam intensities from 1-20m

1m	2m	3m	4m	5m	6m	7m	8m	9m	10m	11m	12m	13m	14m	15m	16m	17m	18m	19m	20m
3.3ft	6.6ft	9.8ft	13.1ft	16.4ft	19.7ft	23ft	26.2ft	29.5ft	32.8ft	36.1ft	39.4ft	42.7ft	45.9ft	49.2ft	52.5ft	55.8ft	59.1ft	62.3ft	65.6ft
6480lx	1620lx	720lx	405lx	259lx	180lx	132lx	101lx	80lx	65lx	54lx	45lx	38lx	33lx	29lx	25lx	22lx	20lx	18lx	16lx
602fcd	150.5fcd	66.9fcd	37.6fcd	24.1fcd	16.7fcd	12.3fcd	9.4fcd	7.4fcd	6fcd	5fcd	4.2fcd	3.6fcd	3.1fcd	2.7fcd	2.4fcd	2.1fcd	1.9fcd	1.7fcd	1.5fcd

The above information is for 3000K colour temperature, for specific module information please see LED spec located on our website

For information regarding other colour temperatures please use the following factors for lumen output and candelas:

2700K = 0.85

Light efficiency:



Light quality:



Color temperature:

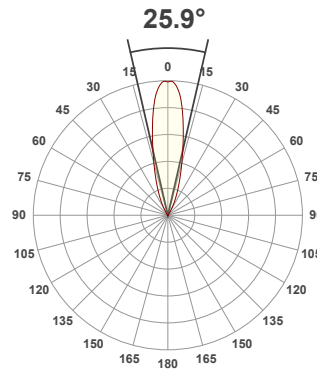

Product name:

090-LED-TL_TR - LED71WD-3020-23

Item number:

Soft90 fixed - LED71WD 3020-23 @ 1000mA

Delivered information for above fixture and LED combination.

Output: 1503 Lumen Peak intensity: 5217 cd Power consumption: 27.5

CRI R values

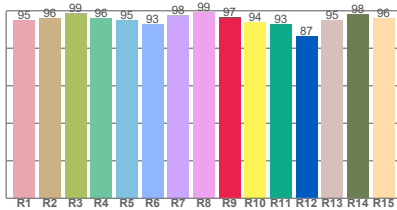

TM30 C Values

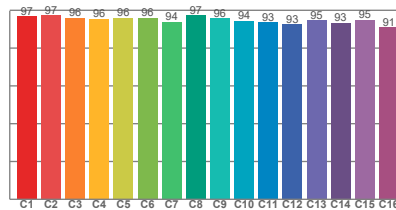

Color vector graphics

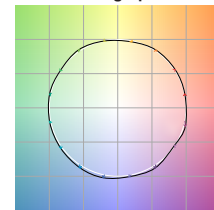

Color temperature	Color rendering index	Red component	Color fidelity	Color gamut	Color quality scale	Color coordinate cie 1931	Color coordinate cie 1931	Color coordinate	Color coordinate	Color deviation from black body
CCT	CRI	CRI R9	TM30 Rf	TM30 Rg	CQS	x	y	u	v	Δuv
3000 K	96.3	96.7	95.1	102.7	95.5	0.437	0.404	0.251	0.348	-0.0045

Beam details

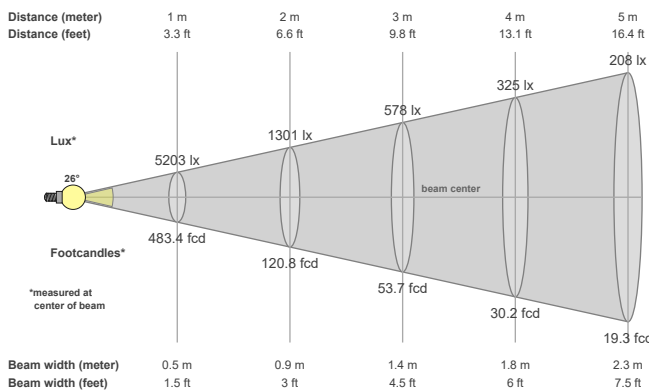

Beam angels

Beam angle 50%	Field angle 10%	Cutoff angle 2,5%
25.9°	53.5°	68°

Beam intensities

Peak intensity	Int. ratio in 120° cone	Int. ratio in 90° cone
5217 cd	97.4%	94.0%

Beam intensities from 1-20m

1m	2m	3m	4m	5m	6m	7m	8m	9m	10m	11m	12m	13m	14m	15m	16m	17m	18m	19m	20m
3.3ft	6.6ft	9.8ft	13.1ft	16.4ft	19.7ft	23ft	26.2ft	29.5ft	32.8ft	36.1ft	39.4ft	42.7ft	45.9ft	49.2ft	52.5ft	55.8ft	59.1ft	62.3ft	65.6ft
5203lx	1301lx	578lx	325lx	208lx	145lx	106lx	81lx	64lx	52lx	43lx	36lx	31lx	27lx	23lx	20lx	18lx	16lx	14lx	13lx
483.4fcd	120.8fcd	53.7fcd	30.2fcd	19.3fcd	13.4fcd	9.9fcd	7.6fcd	6fcd	4.8fcd	4fcd	3.4fcd	2.9fcd	2.5fcd	2.1fcd	1.9fcd	1.7fcd	1.5fcd	1.3fcd	1.2fcd

The above information is for 3000K colour temperature, for specific module information please see LED spec located on our website

For information regarding other colour temperatures please use the following factors for lumen output and candelas:

2700K = 0.85

Light efficiency:



Light quality:



Color temperature:

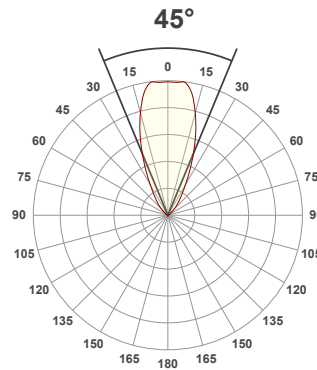
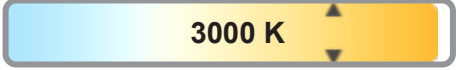

Product name:

093-LED-TL_TR - LED71WD-3020-42

Item number:

Soft90 Accent - LED71WD 3020-42 @ 1000mA

Delivered information for above fixture and LED combination.

Output: 1582 Lumen Peak intensity: 2243 cd Power consumption: 27.5

CRI R values

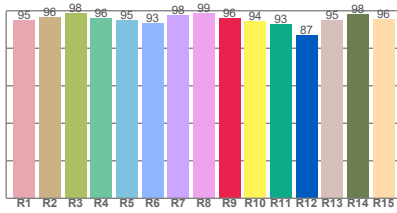

TM30 C Values

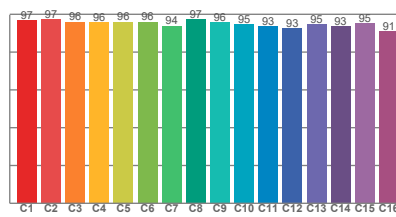

Color vector graphics

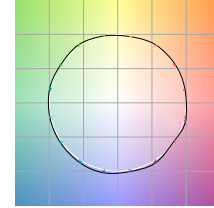

Color temperature	Color rendering index	Red component	Color fidelity	Color gamut	Color quality scale	Color coordinate cie 1931	Color coordinate cie 1931	Color coordinate	Color coordinate	Color deviation from black body
CCT	CRI	CRI R9	TM30 Rf	TM30 Rg	CQS	x	y	u	v	Δuv
3000 K	96.4	96.3	95.2	102.8	95.5	0.437	0.404	0.251	0.348	-0.0044

Beam details

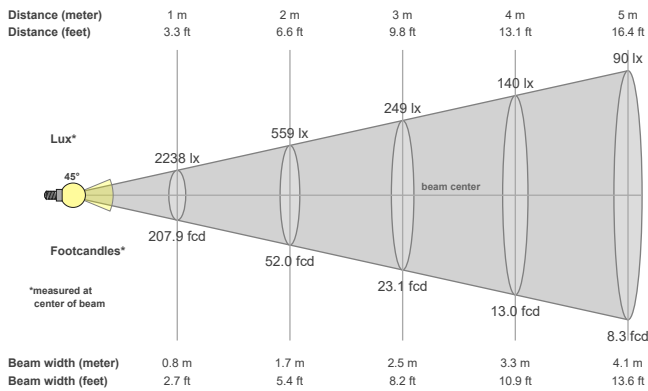

Beam angels

Beam angle 50%	Field angle 10%	Cutoff angle 2,5%
45°	83.7°	107.8°

Beam intensities

Peak intensity	Int. ratio in 120° cone	Int. ratio in 90° cone
2243 cd	97.6%	91.5%

Beam intensities from 1-20m

1m	2m	3m	4m	5m	6m	7m	8m	9m	10m	11m	12m	13m	14m	15m	16m	17m	18m	19m	20m
3.3ft	6.6ft	9.8ft	13.1ft	16.4ft	19.7ft	23ft	26.2ft	29.5ft	32.8ft	36.1ft	39.4ft	42.7ft	45.9ft	49.2ft	52.5ft	55.8ft	59.1ft	62.3ft	65.6ft
2238lx	559lx	249lx	140lx	90lx	62lx	46lx	35lx	28lx	22lx	18lx	16lx	13lx	11lx	10lx	9lx	8lx	7lx	6lx	6lx
207.9fcd	52fcd	23.1fcd	13fcd	8.3fcd	5.8fcd	4.2fcd	3.2fcd	2.6fcd	2.1fcd	1.7fcd	1.4fcd	1.2fcd	1.1fcd	0.9fcd	0.8fcd	0.7fcd	0.6fcd	0.6fcd	0.5fcd

The above information is for 3000K colour temperature, for specific module information please see LED spec located on our website

For information regarding other colour temperatures please use the following factors for lumen output and candelas:

2700K = 0.85