



## ProSpex Flare90 Part L Compliant Fixed Downlight

TM65.2	11kgCO2e
TM66	2.3 CEAM



92mm (3.62") overall diameter. Available with standard trim kit or plaster-in kit for flush appearance. Family of matching products also available. Required depth height + 25mm^

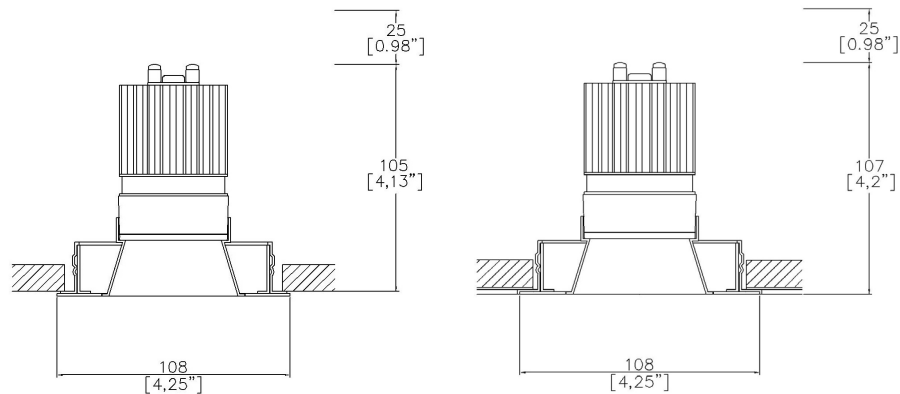

930-FL-LED + 9000-PBZ  
Cut-out 83mm Ø

930-FL-LED + 9000-PCZ  
Cut-out 83mm Ø

LED Source	LED51/Q-HE	LED51/Q-HE	LED51/Q-HE	LED51/Q-HE
CCT	3000K	3000K	3000K	3000K
Drive Current	200mA	200mA	200mA	200mA
Power inc Driver	8.0W	8.0W	8.0W	8.0W
Beam Angle	NF (18°)	MF (25°)	FL (35°)	WFL (55°)
Delivered Lumens	1066	1082	1056	1079
Delivered Intensisty cd	7369	4686	2883	1463
Delivered Lumens per circuit watt	133	135	132	135
Forward Volt	33V	33V	33V	33V
CRI	≥93 CRI	≥93 CRI	≥93 CRI	≥93 CRI



Lumen output for other CCTs use the following multiplication factors to the 3000K figures above: 2700K x 0.98. 4000K x 1.02

Project Ref: \_\_\_\_\_

Location Ref: \_\_\_\_\_

Fixture Order Code:  -  -

Fixture  
930-FL-LED      Flare90 Fixed with LED51 High Efficacy

Finish

WH	White
BK	Black
RAL	Custom RAL Finish*
ABR1	Antique Brass
ABZ1	Antique Bronze
PCH1	Polished Chrome
PNK1	Polished Nickel
PBR1	Polished Brass

IP Rating

44	IP44
54	IP54

Installation Order Code:

Installation

9000-PBZ	Trim kit for trimmed appearance
9000-PCZ	Plaster-kit for seamless flush appearance

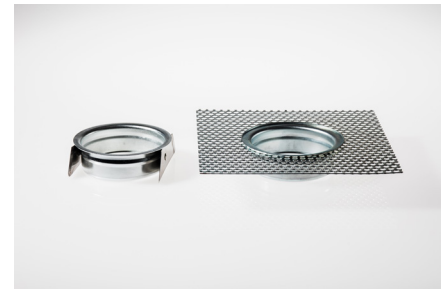

Module Order Code:  -  -

LED  
LED51/Q-HE      LED50 ONE QUANTUM HE

CCT

27	2700K
30	3000K
40	4000K***

Beam

NF	Narrow Flood
MF	Medium Flood
FL	Flood
WFL	Wide Flood

\*\*\*contact Lucent for availability

Driver Options:

Protocol

S	Non-Dim
A	Analogue (0-10v)
P	Phase
D	DALI
B	Bluetooth**

Emergency Options:

Emergency

E	Maintained 3hr Emergency
ED	Maintained 3hr DALI Self Test
ES	Maintained 3hr Self Test

### Finish selection

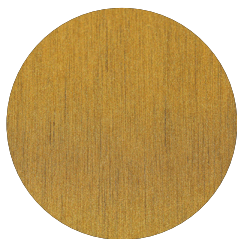

Antique Brass



Antique Bronze

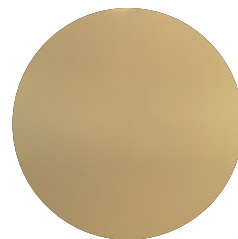

Polished Brass

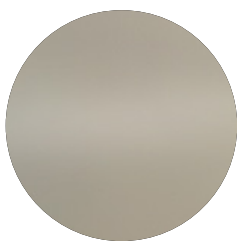

Polished Nickel



Polished Chrome

### Accessories

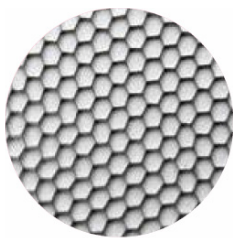

Honeycomb Louvre

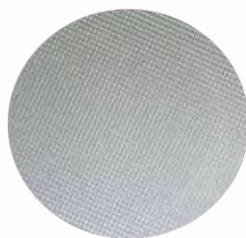

Diffusing Lens



Frosted Lens

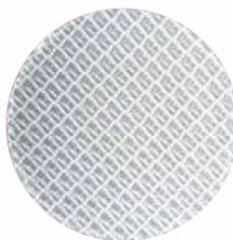

Heavy Spread Lens



Linear Spread Lens

Accessories Order Code:

Louvre/Lens

- LL45 Honeycomb Louvre
- LLCC Warm Tone Lens
- LLUV UV Lens
- LLDF Diffusing Lens
- LLFR Frosted Lens
- LLLS Linear Spread Lens
- LLHS Heavy Spread Lens

## Technical Details

\*Custom RAL code must be specified. Custom RAL colours can increase prices and lead times

Dimming. Whilst Lucent can offer the majority of its luminaires with various dimming options, it remains the responsibility of the specifier/installer to check and ensure compatibility of any control equipment used. Additional cabling may be required depending on the dimming protocol specified.

\*\*Bluetooth (wireless) is the communication method. The exact dimming protocol must be confirmed to allow the selection of suitable drivers or bluetooth devices.

^ Depth indicated is the minimum recess depth for the luminaire with a remote mounted LED driver. Installing a driver through either the luminaire cut-out or installation kit may require additional recess depth, please refer to the relevant luminaire installation instructions for further details. Data correct at time of publishing

First Fix Requirement. Luminaire comprised of fixture body with ceiling trim and installation kit, which is to be fitted into the ceiling once finished. Ensure correct alignment of the installation kit before final assembly (see luminaire installation instructions for details)

IP Rating. Tested from underside of the ceiling

Note that the picture of the finishes provided is for illustrative purposes only. The finishes may vary in colour, texture and appearance. Contact Lucent lighting Ltd for more information.

It is the policy of Lucent Lighting to continually review and improve its products and therefore reserve the right to change any details of product or withdraw specifications without prior notice.

Luminaires designed to comply with EN60598 and all other standards.

This specification sheet supersedes all previous versions.

All intellectual property rights pertaining to the product described above and to this document are owned by or licensed to Lucent Lighting Ltd.

We reserve the right to take whatever action is necessary to protect those intellectual property rights.