

# EasyFit Edge3.5 Wallwash

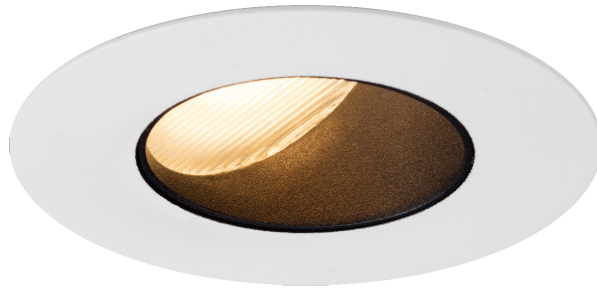

3.62" (92mm) overall diameter. Available with a separate installation kit with overlap flange or mud-in kit for seamless flush finish. Adjustable and wallwash version available. Supplied with a remote driver box and a plug and play tethered power supply. Also for mounting to T-Bar on grid ceilings.

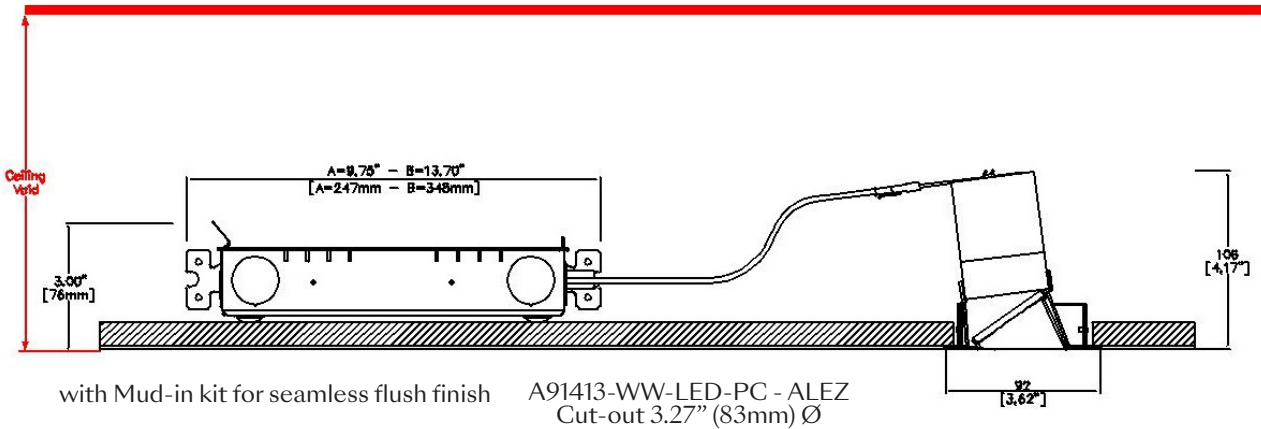
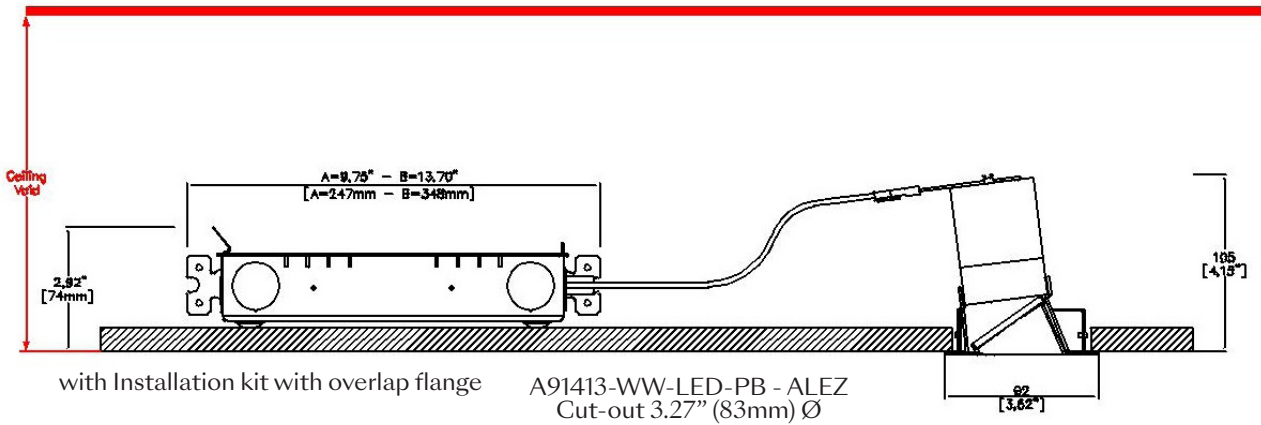

LED Source	LED51/2	LED51/U
CCT	3000K	3000K
Drive Current	350mA	350mA
Power inc Driver	13.6W	13.6W
Beam Angle	38°	38°
Delivered Lumens	590	501
Delivered Intensity cd	424	360
Efficacy lm/w	31	26
Forward Volt	33V	33V
CRI	≥90 CRI	≥98 CRI

Ceiling void minimum depth: Driver box A - 11.00" (280mm) / Driver box B - 14.96" (380mm)

Project Ref: \_\_\_\_\_

Location Ref: \_\_\_\_\_

Specify fixture part number (All boxes must be filled in to correctly order)

<b>A91413-WW-LED</b>								<b>38</b>	<b>ALEZ</b>			
----------------------	--	--	--	--	--	--	--	-----------	-------------	--	--	--

Installation \_\_\_\_\_

**PB** Installation kit with overlap flange

**PC** Mud-in kit for seamless flush finish

Finish \_\_\_\_\_

**WH** White

**BK** Black

**RAL** Custom\*

Location \_\_\_\_\_

**XX** Dry

**DP** Damp

**WT** Wet

Ceiling Thickness \_\_\_\_\_

**SC** Standard Ceiling (1/2"-5/8"-3/4")

**C** Custom

LED Type \_\_\_\_\_

**LED51/2** LED51/2 (90CRI)

**LED51/U** LED51/U (98CRI - Not available with 4000K)

CCT \_\_\_\_\_

**27** 2700K

**30** 3000K

**35** 3500K

**40** 4000K (90 CRI ONLY)

Beam Angles \_\_\_\_\_

**38** 38

EasyFit \_\_\_\_\_

**ALEZ** Lucent EasyFit

Supply Voltage \_\_\_\_\_

**120** 120V

**277** 277V

Dimming Protocol \_\_\_\_\_

**S** Non-Dimmable (Driver Box A - 9.75")

**P** TRIAC/Phase (120V ONLY) (Driver Box A - 9.75")

**LPE** Lutron Hi-Lume Premier 0.1% EcoSystem (Driver Box A - 9.75")

**A** Analog (0-10V) (Driver Box A - 9.75")

**ESD** EldoLED Solo DALI (0.1% Dimming) (Driver Box B - 13.70")

**EED** EldoLED Eco DALI (1% Dimming) (Driver Box B - 13.70")

**ESA** EldoLED Solo Analog (0-10V) (0.1% Dimming) (Driver Box B - 13.70")

**EEA** EldoLED Eco Analog (0-10V) (1% Dimming) (Driver Box B - 13.70")

Louvre/Lens \_\_\_\_\_

**XX** Not required

**LL45** Honeycomb

**LLCC** Warm Tone

**LLUV** UV



**NIC - No contact with insulation**

**Ceiling void minimum depth: Driver box A - 11.00" (280mm) / Driver box B - 14.96" (380mm)**

Driver Boxes

Driver Box A

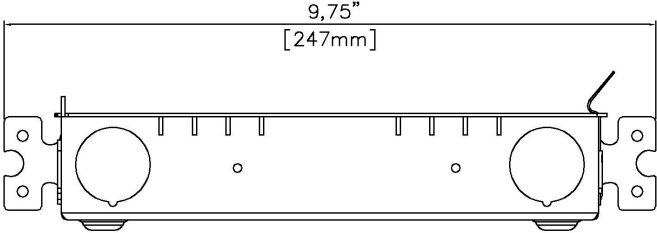
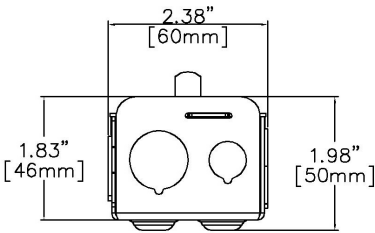

Driver Box B

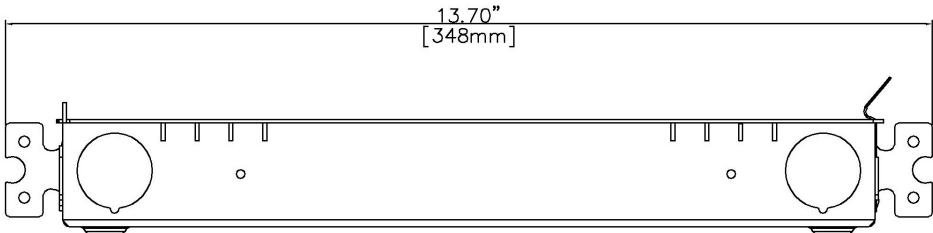
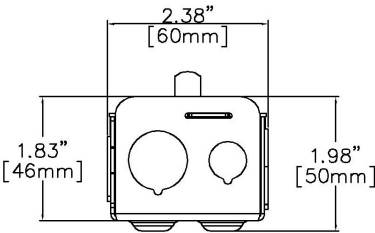

Installation kit with overlap flange



Mud-in kit for seamless flush finish

Ceiling void minimum depth: Driver box A - 11.00" (280mm) / Driver box B - 14.96" (380mm)

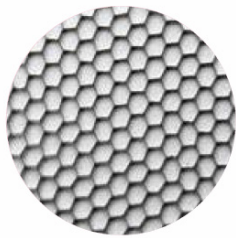

**Honeycomb Louvre (LL45)**



**Warm Tone (LLCC)**

---

## Technical Details

\*Custom RAL code must be specified. Custom RAL colours can increase prices and lead times

Dimming. Whilst Lucent can offer the majority of its luminaires with various dimming options, it remains the responsibility of the specifier/installer to check and ensure compatibility of any control equipment used. Additional cabling may be required depending on the dimming protocol specified.

^ Depth indicated is the minimum recess depth for the luminaire with a remote mounted LED driver. Installing a driver through either the luminaire cut-out or installation kit may require additional recess depth, please refer to the relevant luminaire installation instructions for further details. Data correct at time of publishing

First Fix Requirement. Luminaire comprised of fixture body with ceiling trim and installation kit, which is to be fitted into the ceiling once finished. Ensure correct alignment of the installation kit before final assembly (see luminaire installation instructions for details)

Location. Tested from underside of the ceiling

It is the policy of Lucent Lighting to continually review and improve its products and therefore reserve the right to change any details of product or withdraw specifications without prior notice.

This specification sheet supersedes all previous versions.

All intellectual property rights pertaining to the product described above and to this document are owned by or licensed to Lucent Lighting Ltd.

We reserve the right to take whatever action is necessary to protect those intellectual property rights.

Please notify Lucent Lighting Ltd of any inaccuracies immediately. E&OE

---



**Light efficiency:**

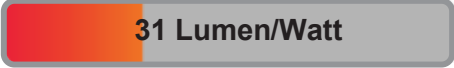

**Light quality:**



**Color temperature:**

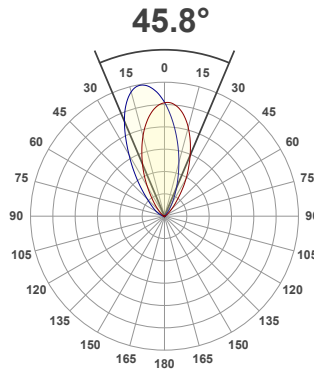

**Product name:**

**91413-WW-LED - LED51\_2-30-38-350mA**

**Item number:**

**Edge 90 Wallwash - LED51\_2-30-38-350mA**

**Delivered information for above fixture and LED combination.**

**Output: 424 Lumen    Peak intensity: 590 cd    Power consumption: 13.6**

**CRI R values**

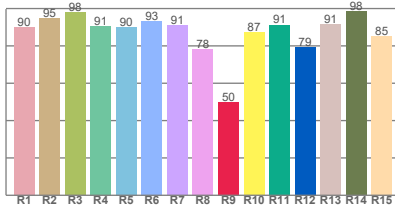

**TM30 C Values**

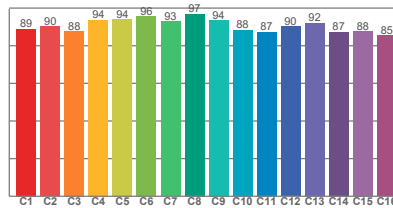

**Color vector graphics**

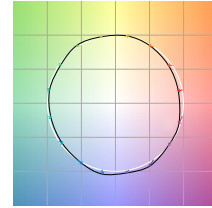

Color temperature	Color rendering index	Red component	Color fidelity	Color gamut	Color quality scale	Color coordinate cie 1931	Color coordinate cie 1931	Color coordinate	Color coordinate	Color deviation from black body
CCT	CRI	CRI R9	TM30 Rf	TM30 Rg	CQS	x	y	u	v	Δuv
3000 K	90.7	49.9	90.8	98.9	89.4	0.437	0.404	0.248	0.347	0.0002

**Beam details**

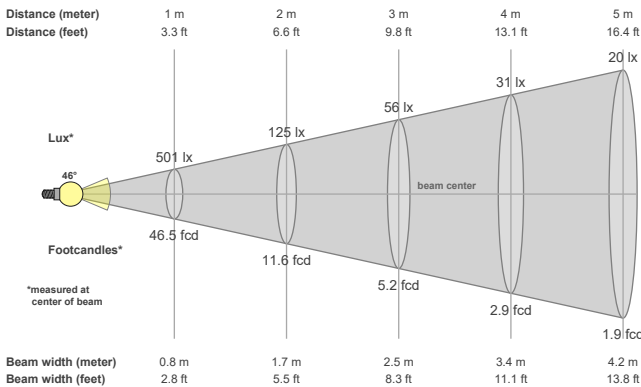

**Beam angles**

Beam angle 50%	Field angle 10%	Cutoff angle 2,5%
45.8°	86.2°	112.6°

**Beam intensities**

Peak intensity	Int. ratio in 120° cone	Int. ratio in 90° cone
590 cd	96.6%	87.9%

**Beam intensities from 1-20m**

1m	2m	3m	4m	5m	6m	7m	8m	9m	10m	11m	12m	13m	14m	15m	16m	17m	18m	19m	20m
3.3ft	6.6ft	9.8ft	13.1ft	16.4ft	19.7ft	23ft	26.2ft	29.5ft	32.8ft	36.1ft	39.4ft	42.7ft	45.9ft	49.2ft	52.5ft	55.8ft	59.1ft	62.3ft	65.6ft
501lx	125lx	56lx	31lx	20lx	14lx	10lx	8lx	6lx	5lx	4lx	3lx	3lx	3lx	2lx	2lx	2lx	2lx	1lx	1lx
46.5fcd	11.6fcd	5.2fcd	2.9fcd	1.9fcd	1.3fcd	0.9fcd	0.7fcd	0.6fcd	0.5fcd	0.4fcd	0.3fcd	0.3fcd	0.2fcd	0.2fcd	0.2fcd	0.2fcd	0.1fcd	0.1fcd	0.1fcd

The above information is for 3000K colour temperature, for specific module information please see LED spec located on our website

For information regarding other colour temperatures please use the following factors for lumen output and candelas:

2700K = 1  
4000K = 1.084

**Light efficiency:**

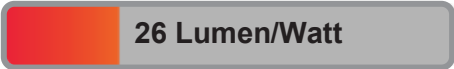

**Light quality:**



**Color temperature:**

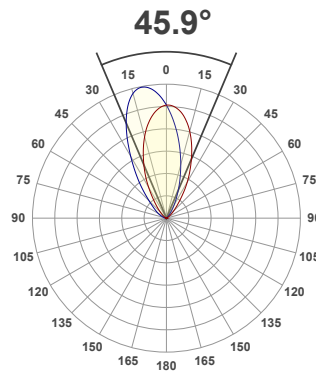

**Product name:**

**91413-WW-LED - LED51\_U-30-38-350mA**

**Item number:**

**Edge 90 Wallwash - LED51\_U-30-38-350mA**

**Delivered information for above fixture and LED combination.**

**Output: 360 Lumen    Peak intensity: 501 cd    Power consumption: 13.6**

**CRI R values**

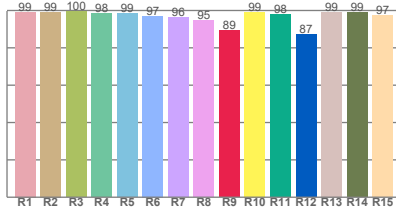

**TM30 C Values**

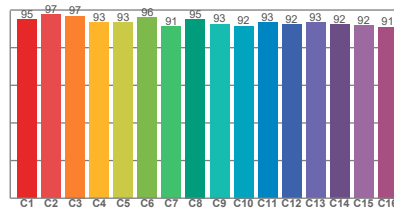

**Color vector graphics**

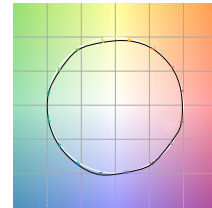

Color temperature	Color rendering index	Red component	Color fidelity	Color gamut	Color quality scale	Color coordinate cie 1931	Color coordinate cie 1931	Color coordinate	Color coordinate	Color deviation from black body
CCT	CRI	CRI R9	TM30 Rf	TM30 Rg	CQS	x	y	u	v	Δuv
3000 K	97.9	89.2	93.8	98.6	95.4	0.437	0.404	0.248	0.347	0.0007

**Beam details**

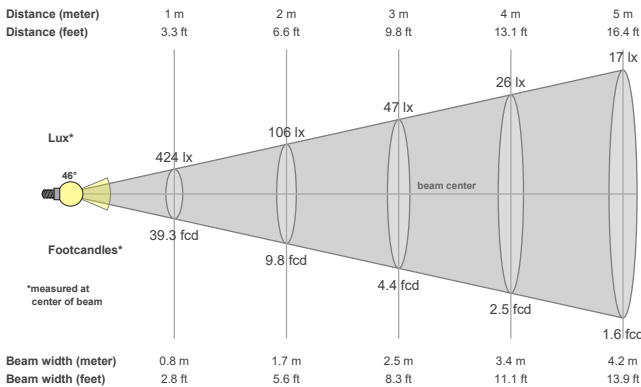

**Beam angles**

Beam angle 50%	Field angle 10%	Cutoff angle 2,5%
45.9°	86.1°	112.7°

**Beam intensities**

Peak intensity	Int. ratio in 120° cone	Int. ratio in 90° cone
501 cd	96.5%	87.9%

**Beam intensities from 1-20m**

1m	2m	3m	4m	5m	6m	7m	8m	9m	10m	11m	12m	13m	14m	15m	16m	17m	18m	19m	20m
3.3ft	6.6ft	9.8ft	13.1ft	16.4ft	19.7ft	23ft	26.2ft	29.5ft	32.8ft	36.1ft	39.4ft	42.7ft	45.9ft	49.2ft	52.5ft	55.8ft	59.1ft	62.3ft	65.6ft
424lx	106lx	47lx	26lx	17lx	12lx	9lx	7lx	5lx	4lx	4lx	3lx	3lx	2lx	2lx	2lx	1lx	1lx	1lx	1lx
39.3fcd	9.8fcd	4.4fcd	2.5fcd	1.6fcd	1.1fcd	0.8fcd	0.6fcd	0.5fcd	0.4fcd	0.3fcd	0.3fcd	0.2fcd	0.2fcd	0.2fcd	0.2fcd	0.1fcd	0.1fcd	0.1fcd	0.1fcd

The above information is for 3000K colour temperature, for specific module information please see LED spec located on our website

For information regarding other colour temperatures please use the following factors for lumen output and candelas:

2700K = 1