

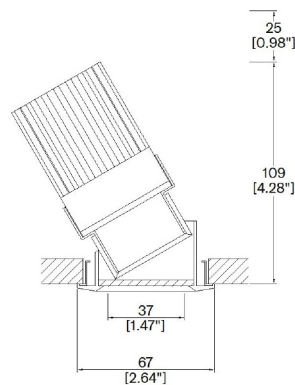

## ProSpex Focus60 Accent



67mm (2.64") overall diameter. Up to 25° tilt. Available with standard trim kit. Family of matching products also available. Required depth height + 25mm<sup>^</sup>



063-LED-65  
Cut-out 62mm Ø

LED Source	LED51TW	LED51TW
CCT range	@ 3000K	@ 3000K
Drive Current (max per channel)	700mA	700mA
Power inc Driver Max	15.1W	15.1W
Beam Angle	25°	35°
Delivered Lumens	422	510
Delivered Intensity cd	1664	1119
Efficacy lm/w	28	34
Forward Volt (max per channel)	18.4V	18.4V
CRI	≥95 CRI	≥95 CRI

Project Ref: \_\_\_\_\_

Location Ref: \_\_\_\_\_

### Fixture Order Code:

063-LED	-	65	-		-	
---------	---	----	---	--	---	--

Fixture  
063-LED

Focus60 Accent with LED51

IP Rating  
65

IP65

Finish  
WH  
BK  
RAL

White  
Black  
Custom RAL Colour\*

Emergency  
E  
ED  
ES

Maintained 3hr Emergency  
Maintained 3hr DALI Self Test  
Maintained 3hr Self Test



### LED Order Code:

LED51TW	-	5020	-		-	
---------	---	------	---	--	---	--

LED  
LED51TW

LED50 ONE Tuneable White

CCT  
5020

5000K - 2000K

Beam  
25  
35

25°  
35°

Protocol  
D6  
D8  
B

DALI Type 6\*\*  
DALI Type 8\*\*  
Bluetooth\*\*\*

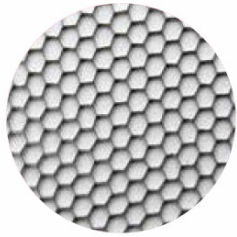

**Honeycomb Louvre**



**Diffusing Lens**



**Frosted Lens**



**Heavy Spread Lens**



**Linear Spread Lens**



**Warm Tone**

Accessories Order Code:

**Louvre/Lens**

- LL45 Honeycomb Louvre
- LLCC Warm Tone Lens
- LLUV UV Lens
- LLDF Diffusing Lens
- LLFR Frosted Lens
- LLLS Linear Spread Lens
- LLHS Heavy Spread Lens

## Technical Details

\*Custom RAL code must be specified. Custom RAL colours can increase prices and lead times

Dimming. Whilst Lucent can offer the majority of its luminaires with various dimming options, it remains the responsibility of the specifier/installer to check and ensure compatibility of any control equipment used. Additional cabling may be required depending on the dimming protocol specified.

\*\*DALI Type 6 requires two DALI addresses, one for CCT control the other for Intesity control. DALI Type 8 is a single DALI Type 8 address for CCT and Intesity control. Please check which control system is being used before specifying.

\*\*\*Bluetooth (wireless) is the communication method. The exact dimming protocol must be confirmed to allow the selection of suitable drivers or bluetooth devices.

^ Depth indicated is the minimum recess depth for the luminaire with a remote mounted LED driver. Installing a driver through either the luminaire cut-out or installation kit may require additional recess depth, please refer to the relevant luminaire installation instructions for further details. Data correct at time of publishing

First Fix Requirement. Luminaire comprised of fixture body with ceiling trim and installation kit, which is to be fitted into the ceiling once finished. Ensure correct alignment of the installation kit before final assembly (see luminaire installation instructions for details)

IP Rating. Tested from underside of the ceiling

It is the policy of Lucent Lighting to continually review and improve its products and therefore reserve the right to change any details of product or withdraw specifications without prior notice.

Luminaires designed to comply with EN60598 and all other standards.

This specification sheet superseded all previous versions.

All intellectual property rights pertaining to the product described above and to this document are owned by or licensed to Lucent Lighting Ltd.

We reserve the right to take whatever action is necessary to protect those intellectual property rights.

Please notify Lucent Lighting Ltd of any inaccuracies immediately. E&OE

**Light efficiency:**

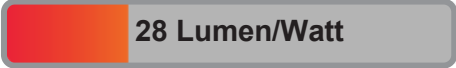

**Light quality:**



**Color temperature:**

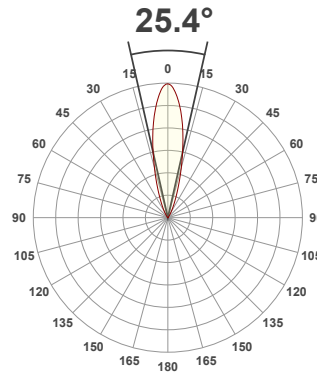

Product name:

**Focus60-90-MULTI - LED51TW-5020-25 @ 3000K**

Item number:

**Focus60-90-MULTI - LED51TW-5020-25 @ 3000K**

**Delivered information for above fixture and LED combination.**

**Output: 422 Lumen    Peak intensity: 1664 cd    Power consumption: 15.1**

CRI R values

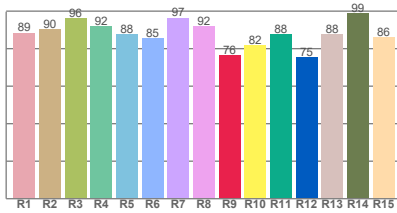

TM30 C Values

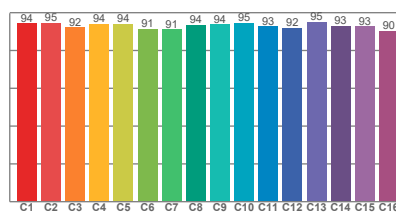

Color vector graphics

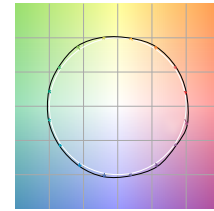

Color temperature	Color rendering index	Red component	Color fidelity	Color gamut	Color quality scale	Color coordinate cie 1931	Color coordinate cie 1931	Color coordinate	Color coordinate	Color deviation from black body
CCT	CRI	CRI R9	TM30 Rf	TM30 Rg	CQS	x	y	u	v	Δuv
3000 K	91.1	76.2	93.4	107.1	93.4	0.437	0.404	0.256	0.335	-0.0139

**Beam details**

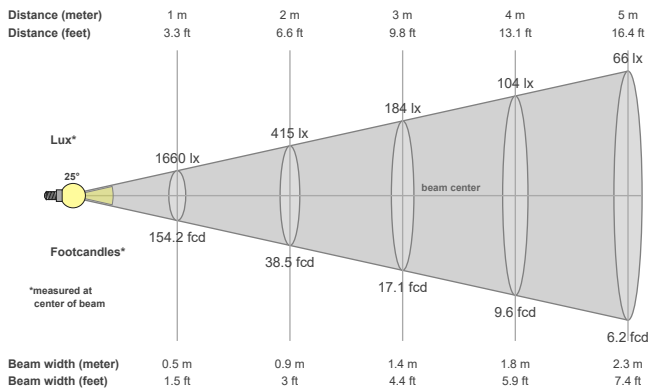

**Beam angels**

Beam angle 50%	Field angle 10%	Cutoff angle 2,5%
25.4°	50.2°	68.4°

**Beam intensities**

Peak intensity	Int. ratio in 120° cone	Int. ratio in 90° cone
1664 cd	99.6%	98.6%

**Beam intensities from 1-20m**

1m	2m	3m	4m	5m	6m	7m	8m	9m	10m	11m	12m	13m	14m	15m	16m	17m	18m	19m	20m
3.3ft	6.6ft	9.8ft	13.1ft	16.4ft	19.7ft	23ft	26.2ft	29.5ft	32.8ft	36.1ft	39.4ft	42.7ft	45.9ft	49.2ft	52.5ft	55.8ft	59.1ft	62.3ft	65.6ft
1660lx	415lx	184lx	104lx	66lx	46lx	34lx	26lx	20lx	17lx	14lx	12lx	10lx	8lx	7lx	6lx	6lx	5lx	5lx	4lx
154.2fcd	38.5fcd	17.1fcd	9.6fcd	6.2fcd	4.3fcd	3.1fcd	2.4fcd	1.9fcd	1.5fcd	1.3fcd	1.1fcd	0.9fcd	0.8fcd	0.7fcd	0.6fcd	0.5fcd	0.5fcd	0.4fcd	0.4fcd

All the above information for fixtures with LED51TW-5020 modules are tested at 3000K

Factors to adjust lumen output for the following CCTs at 100% output for the colour are as follows:

2000K = 0.67

2700K = 0.84

3500K = 1.085

4000K = 1.113

5000K = 1.087

**Light efficiency:**

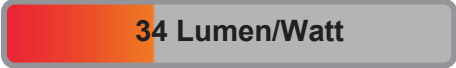

**Light quality:**



**Color temperature:**

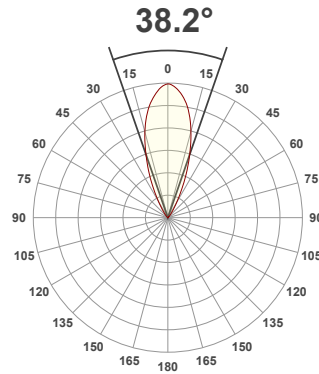

Product name:

**Focus60-90-MULTI - LED51TW-5020-35 @ 3000K**

Item number:

**Focus60-90-MULTI - LED51TW-5020-35 @ 3000K**

**Delivered information for above fixture and LED combination.**

**Output: 510 Lumen Peak intensity: 1119 cd Power consumption: 15.1**

**CRI R values**

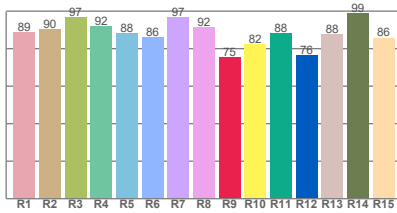

**TM30 C Values**

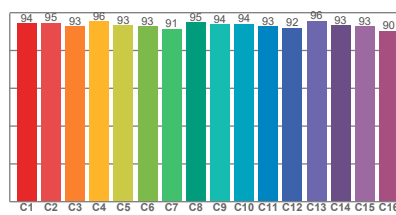

**Color vector graphics**

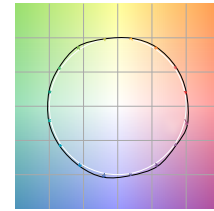

Color temperature	Color rendering index	Red component	Color fidelity	Color gamut	Color quality scale	Color coordinate cie 1931	Color coordinate cie 1931	Color coordinate	Color coordinate	Color deviation from black body
CCT	CRI	CRI R9	TM30 Rf	TM30 Rg	CQS	x	y	u	v	Δuv
3000 K	91.3	75.3	93.6	106.4	93.9	0.437	0.404	0.253	0.334	-0.0135

**Beam details**

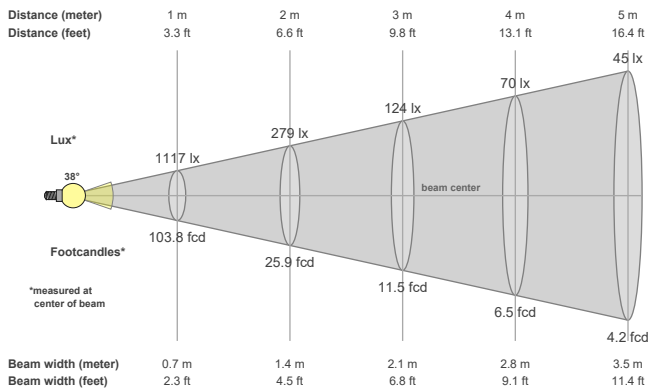

**Beam angels**

Beam angle 50%	Field angle 10%	Cutoff angle 2,5%
38.2°	64.1°	83.9°

**Beam intensities**

Peak intensity	Int. ratio in 120° cone	Int. ratio in 90° cone
1119 cd	99.6%	98.1%

**Beam intensities from 1-20m**

1m	2m	3m	4m	5m	6m	7m	8m	9m	10m	11m	12m	13m	14m	15m	16m	17m	18m	19m	20m
3.3ft	6.6ft	9.8ft	13.1ft	16.4ft	19.7ft	23ft	26.2ft	29.5ft	32.8ft	36.1ft	39.4ft	42.7ft	45.9ft	49.2ft	52.5ft	55.8ft	59.1ft	62.3ft	65.6ft
1117lx	279lx	124lx	70lx	45lx	31lx	23lx	17lx	14lx	11lx	9lx	8lx	7lx	6lx	5lx	4lx	4lx	3lx	3lx	3lx
103.8fcd	25.9fcd	11.5fcd	6.5fcd	4.2fcd	2.9fcd	2.1fcd	1.6fcd	1.3fcd	1fcd	0.9fcd	0.7fcd	0.6fcd	0.5fcd	0.5fcd	0.4fcd	0.4fcd	0.3fcd	0.3fcd	0.3fcd

All the above information for fixtures with LED51TW-5020 modules are tested at 3000K

Factors to adjust lumen output for the following CCTs at 100% output for the colour are as follows:

2000K = 0.67

2700K = 0.84

3500K = 1.085

4000K = 1.113

5000K = 1.087